

## USER'S MANUAL

Operator's Manual for RDWorks / LaserWorks

For the rest of the manual, we will be using "RDWorks" in place of RDWorks / LaserWorks

# For RDWorks V8.01.19

**The original version of this manual has been hacked, there will be no further updates.**

**NOT AFFILIATED WITH: SHENZHEN RUIDA TECHNOLOGY CO.,LTD**

**Manual Lead:**

**Keith Sherwin, Canada.** - Thanks to all the people involved in this project.

**Substantial Proof Reading and Editing by:**

**Cary Reeves, U.S.A.** - Cary went above and beyond in proofing the manual. He caught more mistakes and positioning errors than all the other proof readers combined. If this manual is in any way decent, it is very much because of Cary. Thanks Cary.

**Methods Review by:**

**Russ Sadler, England.**

**ToC and Index provided by:**

**Gareth Lewis at Thinklaser.com, England.**

**Special assistance,**

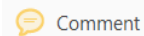
**Doug Fisher U.S.A.**

**Other support,**

**Graphics by: Gene Uselman, U.S.A.**

**Cover Graphic & Forum Header: Sean (snppls)**

To add notes in Adobe Acrobat Reader DC, click on the Comment icon on the right hand panel, and add your comments.



**A message from the team:**

**This is now our only release of the manual. There are mistakes in it.**

To any that wish to complain about the manual,

**As you could have joined the team, but didn't –**

**any complaint is a “Complaint about yourself”.**

**Thank You, The Team.**

**A big thank you to all the others that contributed to this manual.**

## **Chapter 1 Overview**

### **1. 0 Conventions and layout**

**When the verb “Click” is used, it means “Left Click” if a Right Click is needed it will say “Right Click”.**

Many of the commands are written using the format;  
click on menu **[Menu Item Header]** -> [sub menu] -> [sub, sub menu- if needed]  
This means that you should click on the;  
**menu bar** along the screen top **[with the heading]** -> [then, click on the sub menu] -> [then, click on the sub, sub menu-if needed].

An example would be:

click on menu **[Config(S)]** -> [Page Setting]. This means that on the menu bar you should click on the text that says “**Config(S)**” and then click on the line that says “**Page Setting**”.

In the “**Config(S)**” heading above, the (S) indicates a shortcut key. If you press and hold the **Alt** key and press the **S** key, that will give the same result as if you clicked on “**Config(S)**”.

This manual is laid out in four chapters plus an appendix. Each chapter has many sections that are numbered in the following manner. x.x.x.x (where x is a number) The first number is the Chapter Number, the second number is a Topic, and any further numbers indicate greater depth within that topic.

We will use the term “**LCD**” as a substitute for “Digital Control Unit” or HMI “Human Machine Interface” when speaking about saving and memory allocation as well as Data entry. The LCD is the interface to the Control Unit as it is both a keyboard and a display. The LCD is not the control unit, much like a keyboard and monitor are not a computer, however they both are used to supply access to the computer.

### **1.1 Laser Engraving and Cutting System Introduction**

The Laser Engraving and Cutting System uses computer numerical control machine tools to achieve effective control, according to the user’s different design.

The system includes the control board and control panel **LCD**, and supporting software. This manual describes how to use the software to complete the task of laser processing. A separate manual on hardware setup is planned.

### **1.2 Software supported import file formats**

Vector format: dxf, ai, plt, dst, dsb, eps, etc.

Bitmap format: bmp, jpg, gif, png, mng, etc.

#### **1.2.01 Software supported export file formats**

Vector format: ai and plt

### **1.3 Computer Requirements**

The following recommendation represents the minimum requirements. When using a more powerful computer the graphics are generated and displayed faster and the computing times and the data transfer to the laser are reduced. To use a newer software version, you may have to meet other requirements.

- Windows 10, Windows 8/8.1, Windows 7, Windows Vista (with Service Pack 1 or later) and Windows XP (with Service Pack 2 or later)
- 1024 MB of RAM, 400 MB of hard disk space
- Pentium® 3 or 4 processor or AMD Athlon™
- 1024 x 768 or better monitor resolution
- 1 free USB port,
- Mouse
- a supported RUIDA controller in the Laser

#### **IMPORTANT NOTES:**

1). **This manual covers Version 8.01.19.** If you cannot find a feature or function, check that you have **Version 8.01.19** or newer. Click on **HELP | ABOUT RDCam** (Top Line) view the bottom left corner for version number. If certain Shortcuts do not work as you think they should, download and install the “other language files” from RDWorksLab.com.

**RUIDA's English files have many errors.**

Many of the screen grabs in this manual are done with the “**Other\_lang.ini**” (**Other Language**) file in use. The original names are used for the menus with the (**Other Language words**) in ellipses. The English language files that come with RDWorks **contain many errors**. An additional set of language files with corrected English references has been prepared by the authors. They can be installed and accessed as an "Other" language file. This corrected set of files and instructions for installing them are available for download by registered members of <http://rdworkslab.com/> at (<http://rdworkslab.com/viewtopic.php?f=45&t=517>). The shortcuts and screenshots used in this manual are based on these "Other" language files." They **may** also be included with the manual distribution.

We will be using the phrase “**LCD**” for the **Machine Display Panel**. It means “**Liquid Crystal Display**”, and is a common term in industry. Also, **HMI** is another phrase that is common in industry for the LCD control panel. It means “**Human Machine Interface**”.

**Passwords:** There are several passwords used by RDWorks. They are **RD8888**.

**Using these next two on the LCD can cause your settings to be corrupted.**

Set fact para **HF8888** and **ESPECIALLY Def fact para – CC8888 & possibly GXFC88.**

**The laser uses heat to cut and engrave. There have been MANY reports of fires in the laser. Please keep a powder fire extinguisher handy and do not leave your machine operating while you are not in attendance. It only takes 10 seconds for a fire to get out of control.**

**1.04 How to get your Machine to speak English** When many of you get your machine, it will be speaking Chinese. If you don't understand Chinese, this can be a real problem!

I'll guess you don't understand Chinese, so here is a numerical method to teach your Laser to speak English:

1. Power up your Laser.
2. Call up the Menu on the machine by pressing the **Z/U button**, in between the **4 directional arrows**.
3. Press the **DOWN ARROW** key **9 times** to get to the **TOP** of the Menu on the **Right Hand Side**.
4. Press the **Enter** key.
5. Press the **Down Arrow** key 2 times so the third item down is highlighted,
6. Press the **Enter** key.

For the video <https://www.youtube.com/watch?v=UF37pbL2hpw>

You should now have English. There are other choices for Language, so if you want another language select your desired language.

For pictures go to <http://rdworkslab.com/viewtopic.php?f=27&t=187> .

### **1.05 How to teach the Software to Speak English**

In addition to selecting the Language in the installation process, to set the software language you can easily switch to a different language within the software.

Click on menu Bar [Help] -> [Language] ( 7<sup>th</sup> from the left then down 3) and expand the menu, then select the desired language. The third one down is English. In this manual, we are using the Other Language file from RDWorksLab.com. It is the 4<sup>th</sup> selection if you have downloaded the corrected "Other Language" files.

See **Section 2.2 Language settings** for graphics.

### **1.06 IMPORTANT – Make Backups!!**

**You have your new machine and it speaks English, so what's next?**

The first thing you need to do is to hook up the computer to your machine.

**Once that has been accomplished, you need to make a Backup of your machine settings. Should you have troubles in the future, it will be VERY HANDY to have a backup.** Watch **BOTH OF THESE** videos for complete instructions. **RDWorks Learning Lab #74** <https://www.youtube.com/watch?v=h9NCqTT3Sh8> as well as **RDWorks Learning Lab #77** <https://www.youtube.com/watch?v=Y-tva0CSJao>

See **Section 3.3** for instructions on saving the USER "Original.RDUSet" file.

See **Section 4.11** for instructions on saving the "Original.RDVSet" file.

See **Section 4.11.04** for instructions on clearing initially corrupt "Running Data".

**IMPORTANT NOTE:** If your user settings have been changed by you and you are happy with the results, you would be advised to **SAVE** your current settings to the machine, then Read and Save them to your computer as your working backup settings.

## **1.07 HOT KEYS**

Press and Hold the Alt key while pressing the letter after Alt

### **Alt + Letter**

- Alt - F To select the Files Menu
- Alt - E To select the Edit Menu
- Alt - D To select the Draw Menu
- Alt - S To select the Configuration Menu
- Alt - W To select the Handle Menu
- Alt - V To select the View Menu
- Alt - H To select the Help Menu
- Alt - M To select the Model Menu
- Alt - T To select the Tool Menu

Press and Hold the Control (Ctrl) key while pressing the letter after Ctrl

### **Ctrl + Letter**

- Ctrl -A To select All objects
  - Ctrl -C For Copy
  - Ctrl -E For Export
  - Ctrl -I For Import
  - Ctrl -N For New File
  - Ctrl -O For Open .rld files
  - Ctrl -S For Save
  - Ctrl -V For Paste
  - Ctrl -X For Cut
  - Ctrl -Y For Redo
  - Ctrl -Z For Undo
- Press Ctrl and Roll Mouse Wheel to Zoom In or Out at the cursor's location

Press and Hold the Control (Ctrl) key while pressing the Number after Ctrl

### **Control + Number**

- Ctrl -1 Draw Straight Line
- Ctrl -2 Draw Polygon/Polylines
- Ctrl -3 Draw Curves
- Ctrl -4 Draw Rectangles
- Ctrl -5 Draw Ellipses
- Ctrl -6 Draw Text
- Ctrl -7 Draw Point
- Ctrl -8 Twain Import / Capture

## 1.08 Tips – Tricks & Terminology

Objects which are grouped are cut together - grouped inside objects will cut first if they were selected first, then outside objects will be cut.

Setting the background color to a light gray helps with seeing lighter colored layers.

By default, files import to the center of the work area. The import position can be set by clicking on menu [**Config(S)**] -> [Config File Parameter Setting] and selecting the desired position (Figure 1). Once imported, it may be easier to use Ctrl-X to cut, then use Ctrl-V to paste, which will place it centered on where your cursor is currently located.

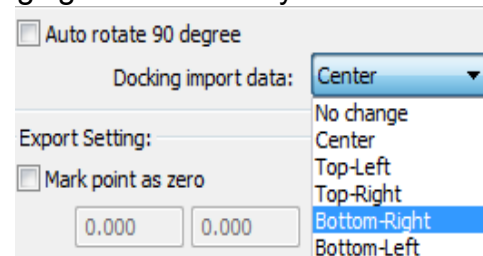


Figure 1.

Text remains editable until you select the Un-group Icon - near Top Right on the Toolbar.

**GO (and GO Scale)** refers to the frame function to check out boundaries.

**Capture** is used to acquire a scan from a Twain Scanner (if installed) .

**Feed param** (Parameters) are for a machine with a conveyor type belt table.

When saving files to a USB Stick/Thumb Drive for use on the machine, you need to use the "SavetoUFile" button, so it is saved as an ".rd" type file and not as a .rld file. When a USB or Ethernet cable is attached from a computer to the Laser, then simply click on "Download" and enter an 8-character or less filename. If you try using a Stick/Thumb Drive with RLD files and NOT using RD files you will fail as **only** RD files can be seen using the Stick/Thumb Drive.

Memory can be overloaded by leaving too many files on the Laser **LCD**. There is a maximum of 100 files. See **Section 3.4** on how to **Delete All** files in the **LCD**.

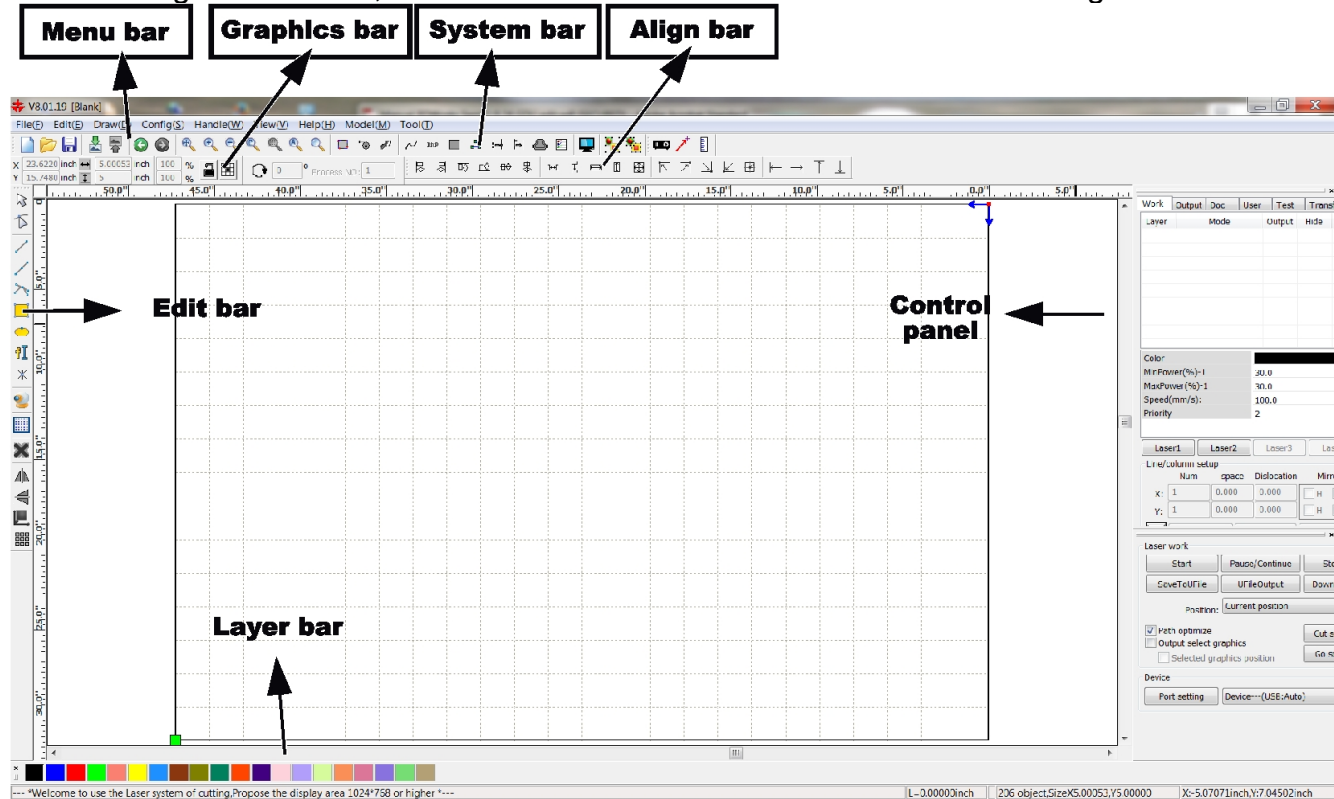
If the images on the **LCD** are **reversed**, they can be fixed using the LCD Panel on the machine. Press the Z/U button, then press up twice to select the option "Screen origin+", and press Enter. The default option seems to be Top Left, change it to **Top Right**. Your files should now display correctly. If they print reversed, then see **Section 3.1**

**"No enough extend space." ERROR** - at the end of each sweep the beam switches off but the head has to travel on as it decelerates to a stop, turn around and accelerate back up to speed before turning the beam on again. If you have set your program to run from 0,0 or a point that does not allow this to happen, this overrun will go outside the allowable work area. You need to leave about 5mm all round when engraving to allow for this, depending on speed. So set your origin at 5,5 and make sure your image is not bigger than 10 mm less than your work area.

## Chapter 2 Software Basic Operation

### 2.01 The main interface operation

After starting the software, the user will see an interface like that shown in Figure 1.



Control panel Figure 2.

**Menu Bar:** The main functions of the software are implemented through the Menu Bar. Commands executed through the Menu Bar include some of the most basic functions, including File, Edit, Draw, Config, Handle, View, Help, Model, and Tool.

**System Bar:** Placed on the System Bar are some of the most commonly used command buttons which are chosen from the menu.

**Graphics Bar:** On the Graphics property bar are the basic attributes of graphics operations, including graphic location, size, scale, and processing number.

**Edit Bar:** The Edit Bar by default is on the left of the work area. On the Edit Bar are placed frequently used tools to make the operation more flexible and convenient.























**Align Bar:** Tools that allow Alignment of the selected objects.

**Layer Bar:** Changes the layer (color) of the selected objects.

**Control Panel:** Use the Control Panel to complete laser processing of multiple tasks, layer parameter settings, axis control, processing, etc.



**Edit Bar Tools**

	<b>Selection Tool</b>
	<b>Edit Node -</b> When selected it pops up the Edit Node tools explained below
	<b>Draw Line –</b> Hold Ctrl while drawing for a straight line. Horizontal or Vertical only.
	<b>Draw Poly Line</b>
	<b>Draw Curve</b>
	<b>Draw Box –</b> Hold Ctrl while drawing for equal sides
	<b>Draw Ellipse –</b> Hold Ctrl while drawing for Circle
	<b>Draw Text</b>
	<b>Point</b>
	<b>Capture from Scanner, Webcam etc.</b>
	<b>LGP Tool for creating light guides</b>
	<b>Delete selected</b>
	<b>Horizontal Mirror</b>
	<b>Vertical Mirror</b>
	<b>Center Data</b>
	<b>Matrix Copy</b>
	<b>The Edit Node Selections</b>
	<b>Plus (+) node –</b> touch and click with the Node Select cursor. A red square will appear. Double click to confirm the Node.
	<b>Negative (-) node –</b> touch and click with the Node Select cursor. A green square will appear. Double click to Delete the Node.
	<b>Combine nodes –</b> select two nodes on different items. They will turn green. Tap on “combine nodes” to join the selections.
	<b>Break a Curve -</b> separate node. Select node, it will turn green. Click on “break a curve” and the object will be separated into two overlapping nodes.
	<b>Select two nodes then click to change a Curve to a straight Line</b>
	<b>If one node is selected, it will turn into a Bezier node that can be curved on both sides. If two nodes are selected, the line between them will be turned to a Bezier curve as well as the line preceding the first created node.</b>

## 2.2 Language settings

During the installation process, the user can easily switch the language in which the application displays commands. The following steps outline the process of changing language in RDWorks.

### 2.2 Language settings and Manufactures Information

In addition to selecting the Language during installation the language can be easily switched within the software.

Click on menu Bar [Help] -> [Language] and expand the menu, then select the desired language. The third one down is English. In this figure, we are using the Other Language file from RDWorksLab.com. It is the 4<sup>th</sup> selection, available from:

<http://rdworkslab.com/viewtopic.php?f=45&t=517>

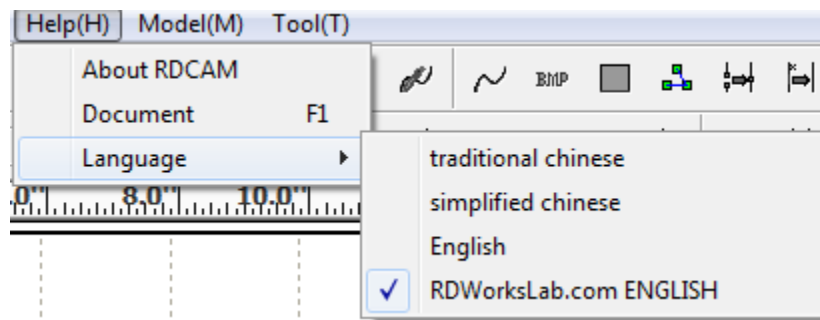


Figure 3

When all Lines are in Chinese, Count down to the 3<sup>rd</sup> line down and click on it.

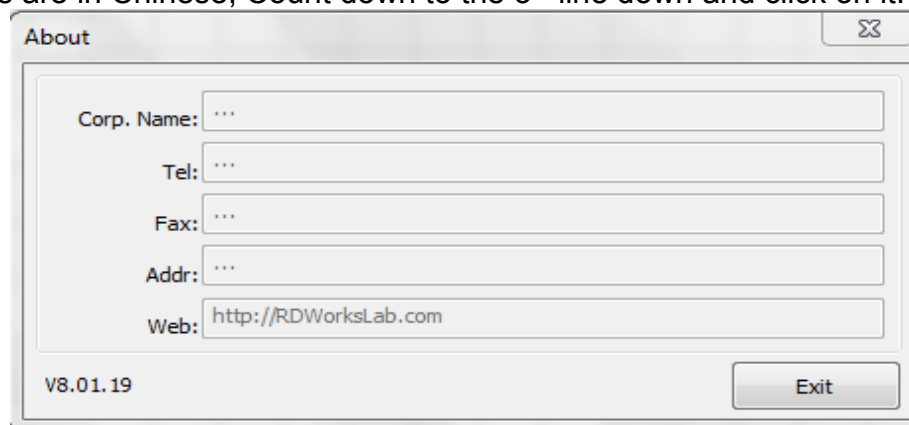


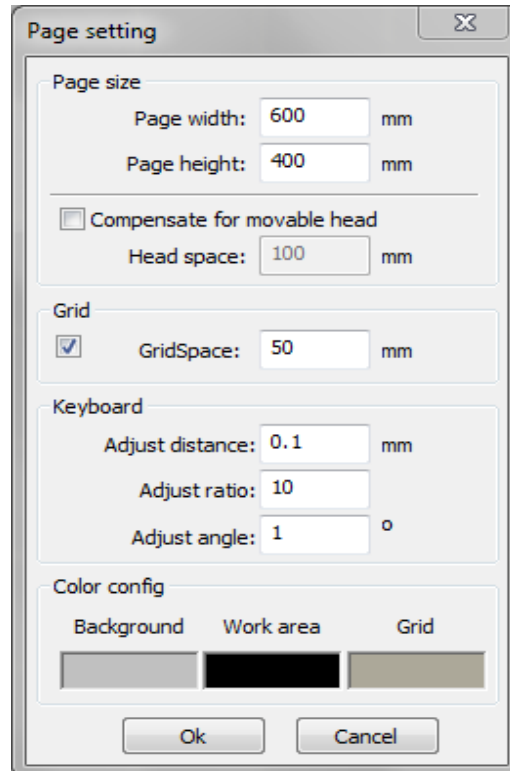
Figure 4

To obtain the manufacturer's information, so that the manufacturer **MIGHT** provide you with better service, Click on menu Bar [Help] -> [About RDCAM]

The bottom of the dialog box shows the current software version number. Different versions of software may have some differences in the functions and interfaces, you **MIGHT** be able to contact and communicate with your manufacturer and inform them of the software version number. This file is stored in the "Info\_eng.txt" file located in the RDWorksV8/Vendor Folder or the Installed Folder/Vendor if you did not install it in the default folder.

## 2.3 Page Setting

To control page setting, click on menu [**Config(S)**] -> [Page setting]. When this is done, the following dialog box appears (as shown in **Figure 5**) :



**Figure 5**

**[Page width]:** Software page width should be the same as the machine X width.

**[Page height]:** Software page height should be the same as the machine Y height.

Once connected to the controller, the software will automatically format the page size for the current operation. However, if the controller is not connected or if a custom page size is needed (such as for adjusting page size to material) , the user can use the page setting to reconfigure the page size as desired.

**[Grid]** Enables and sets the grid spacing. Setting to 25.4 or 50.8 mm will give 1 or 2 inch spacing.


**[Keyboard]** The user can use the arrow keys to move selected graphics. How far it moves is set in Keyboard Settings.

**[Color config]** Sets the color of the work area as well as background and grid colors. Setting the Page Background to a Light Grey helps to see the lighter colored layers.

### 2.4 File Open and Save

The software uses the "rld" file format to save graphic information, layer parameters, and the processing of graphic elements.

#### 2.4.01 Open File

To open a file, click on menu [File] -> [Open], or click on the folder  icon to open the dialog box below: Select the desired file and click on [Open].

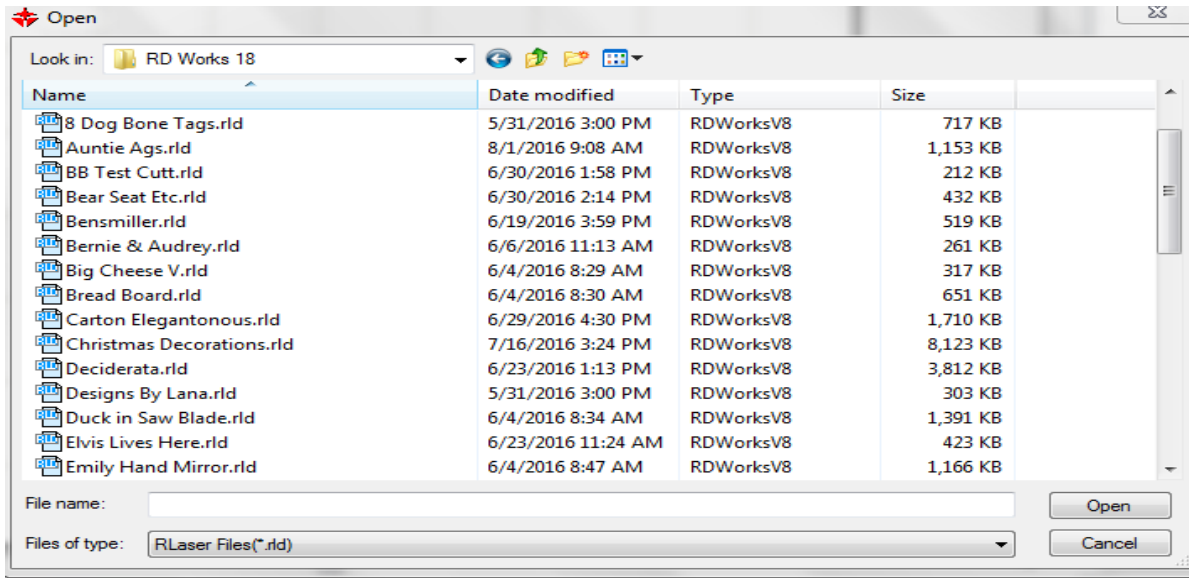



Figure 6

#### 2.4.02 Save File

(1) Click on menu [File] -> [Save], or click the Disk icon . This dialog box appears:

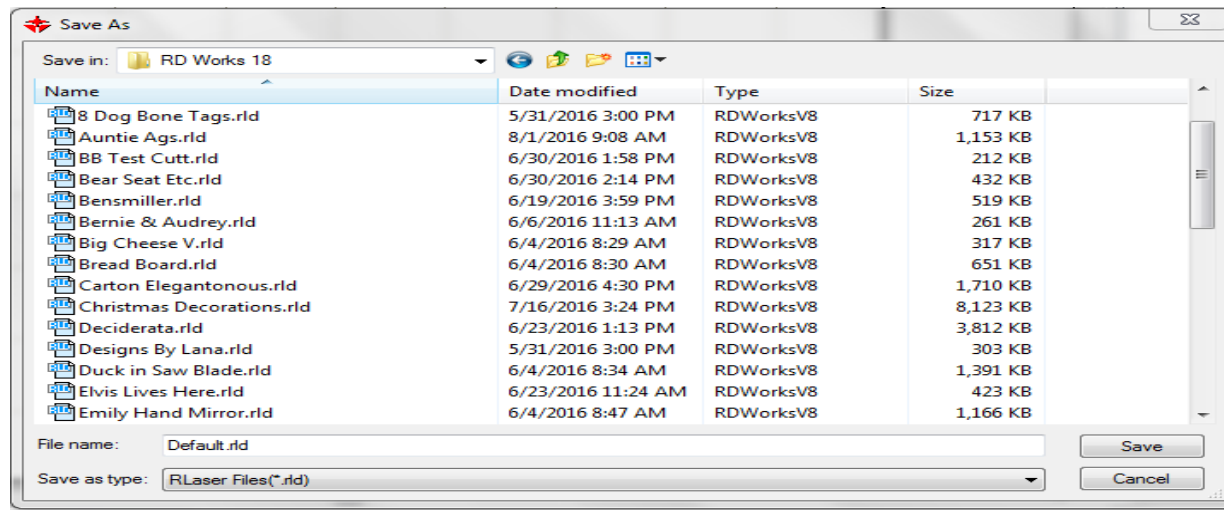


Figure 7

(2) Enter the file name in the edit box, then click on [Save].

## 2.5 File Import and Export

Files not in rld format must be imported, and the Export function must be used to export graphic files for processing by other programs. The file types that can be imported include dxf, ai, plt, dst, and dsb as well as many other formats. Exported files are formatted as plt files or a proprietary ai format that is not readable by most programs other than RDWorks although we hear that Adobe Illustrator CS2 will work with these files. As far as I know, there is NO FREEWARE program that will open this older version of ai file.

### 2.5.01 File Import

To import a file, follow the procedure below.

Click on menu [**File**] -> [Import], or click the Import  icon, to invoke the following dialog box

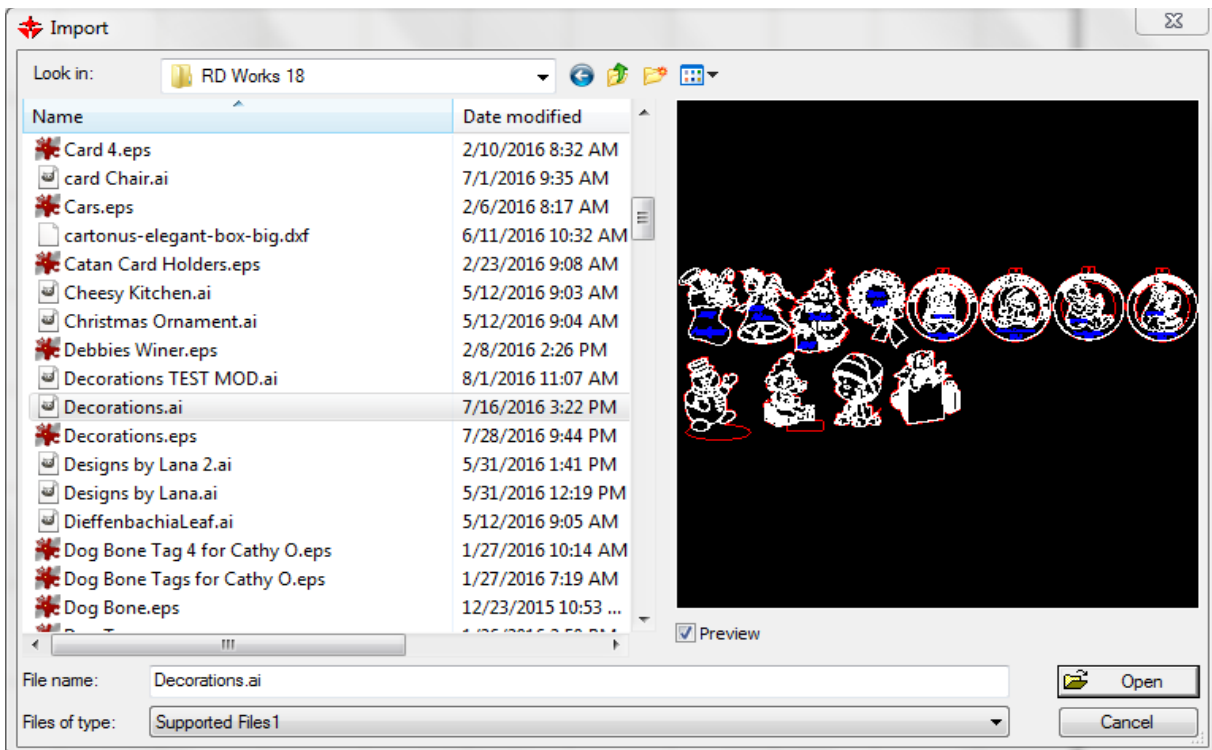



Figure 8

For most vector files, the RDWorks software will automatically import the file into the corresponding layer of RDWorks according to the color layer description as set in your Layer Parameters. See Section 4.10.02.

If the Preview Check box is selected, the file will be shown in the preview screen when selected. Click [Open] to open a selected file.

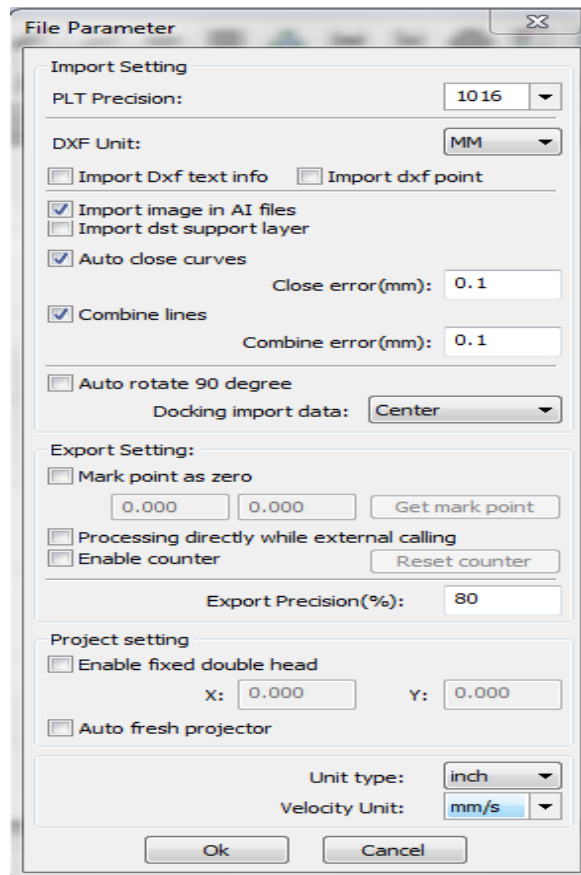
Files by default import to the center of the work area, The import position can be set by clicking on menu [**Config(S)**] -> [File Parameter Setting] -> [Docking Import Data] and selecting the desired position from the drop down menu. See Section 2.5.03. Sometimes it is easier to use Ctrl-X to cut, then use Ctrl-V to place the file **centered** on **where your cursor is currently positioned**.

### 2.5.02 File export

Click on menu **[File]** -> **[Export]** or click the Export  icon. The Export dialog box appears. Input the desired filename, select desired export file type and click the **[Save]** button. This saves in ai and plt formats only. The .ai does not play well with most other (freeware) software. I have been told that Adobe Illustrator CS2 will work with these files. As far as I know, there is NO FREEWARE program that will open this older version of ai file.

### 2.5.03 File parameters setting

Click on menu **[Config(S)]** -> **[File Parameter Setting]**



**Figure 9**

**PLT Precision:** Select the appropriate import accuracy of the original plt file. Set PLT (plotter) precision to match the accuracy of the original plt file. You can enter your desired number or use one of the two defaults of 1016 or 1000.

**DFX Unit:** Choose the units used to import a DXF File. Choices are MM, CM, Inch or Custom.

**Import DXF text info:** Un-check this option if you need the functionality of dxf graphic information, but do not need the text information within the file.

**Import dxf point:** if this is checked, then point data from the dxf will be imported.

**Import image in AI files:** if checked will allow importing an image that is in an ai file.

**Import dst support layer:** DST and LSP - Uses the AutoCAD 2005 Field function to insert drawing name, date, and time of last save.

**Auto-close curves:** This function automatically closes curves and compares them to tolerances set by the user.

**Combine lines:** This function merges lines to user-set tolerances and auto-connects curves.

**Auto Rotate:** When checked it will rotate the imported data by 90 degrees.

**Docking Import Data:** gives 5 choices as to where imported data is placed.

**Export Settings:**

**Mark Point as Zero,** Allows you to set where the origin of the drawing is located.

**Processing while external calling,** allows recursive calling in the software to speed saving in computers with more powerful processors.

**Enable Counting,** allows counting of points processed during export. Can be Reset.

**Export precision:** Sets the Export precision of the plt file or output file. 80% is the default but you may select higher or lower depending on your requirements.

**Project (projector) Setting:**

**Enable fixed double head:** Check this if you have a double headed machine and then enter the X and Y offset of the second head.

**Auto Fresh Projector:** If checked, will automatically refresh the projector if so equipped.

**Unit Type:** Select between inch or millimeter setting. The screen will switch to display in inches or millimeters.

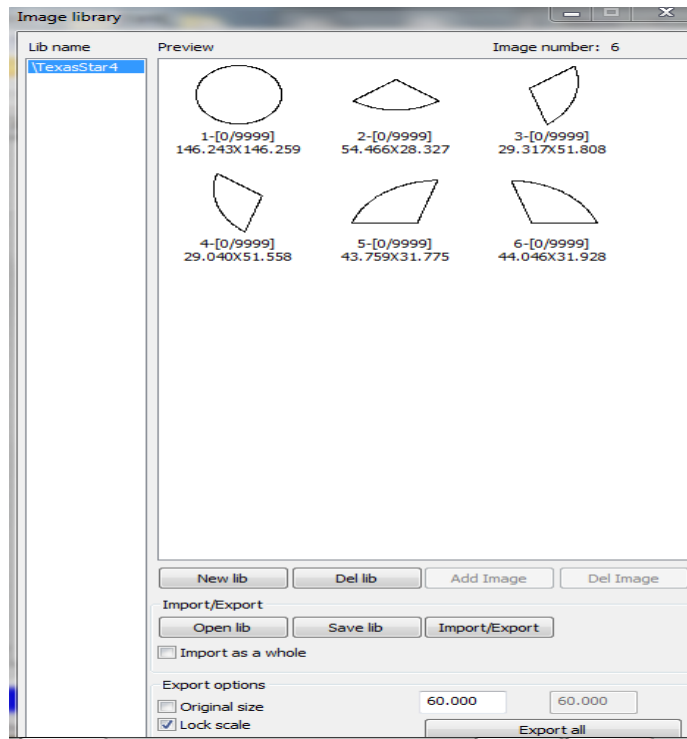
**Velocity unit:** The software supports two types of speed units: millimeters per second (mm/s) and meters per minute (m/min). The speed of the parameters in the Layer Parameters Interface is determined by the speed unit selected.

**Note:** The displayed **unit notation** does NOT change in the Work Tab, on the Speed line but the actual number does change.

### 2.5.04 Image Library

Click on menu [File] -> [Image Library]

Frequently used graphics can be stored in the gallery for ease of use.



**Figure 10**

**New lib:** Creates a new Library which you can Import graphics into.

**Del lib:** Will delete the currently highlighted library.

**Add Image:** Select library name, then the desired image, click on Add Image, enter a name for the image, click “OK”, then click on “Export all”.

**Del Image:** Deletes the currently selected image from the library.

#### Import/Export

**Open lib:** Will open a library for use.

**Save lib:** Will save a Library for later use.

**Import/Export:** Will Import a graphic into a Library. **Export does not seem to work.** There are currently two versions of V8.01.19! A special one for L.O. Ruida controllers may allow Export.

**Import as a whole:** If checked will import the complete file as one piece. If unchecked, the file will be imported in all of its component parts.



### **Export Options:**

**Original size:** if Checked will export into RDWorks at the original size.


If you change the numbers in the selection boxes, The box on the left is for the X dimension, the box on the right is for the Y dimension.

**Lock Scale:** if checked, then only the X dimension can be selected, but the Y dimension will be scaled to be in the proper ratio to the original X & Y dimensional relationship.

**Export all:** will export the graphic to the lower left of the work area.


### **2.6 Creating Basic Graphics**

**Lines (Ctrl+1) :** To draw lines, do the following steps:


Click on menu [**Draw**] -> [Line], or click the Edit Bar icon,  to select the line tool. Click and release in the processing area to create the starting node of the line. Move the pointer to another location and click and release again to create the ending node of the line.

Press the "Ctrl" key while moving the mouse to **draw horizontal or vertical lines**.


**Polygon/Polylines (Ctrl+2) :** To draw poly-lines, do the following steps:

Click on menu [**Draw**] -> [Polygon], or click the Edit Bar icon  to select the polyline tool. Click and release in the processing area to create the starting node of the polyline. Move the pointer to another location and click and release again to create an additional node. Repeat until the desired polyline is complete. Clicking on the starting point creates a closed polygon and resets the tool to start another polyline. Right clicking or pressing "Esc" creates an open polygon and exits the tool.


**Curves (Ctrl+3) :** To draw curves, do the following steps:



Click on menu [**Draw**] -> [Curve], or click the Edit Bar icon  to select the curve tool. The curve tool works much like the polyline tool. Curve nodes have handles that can be manipulated to change the curvature of the segment connecting nodes. Dragging while clicking simultaneously creates a node and curves the segment. Right clicking or pressing "Esc" exits the tool.

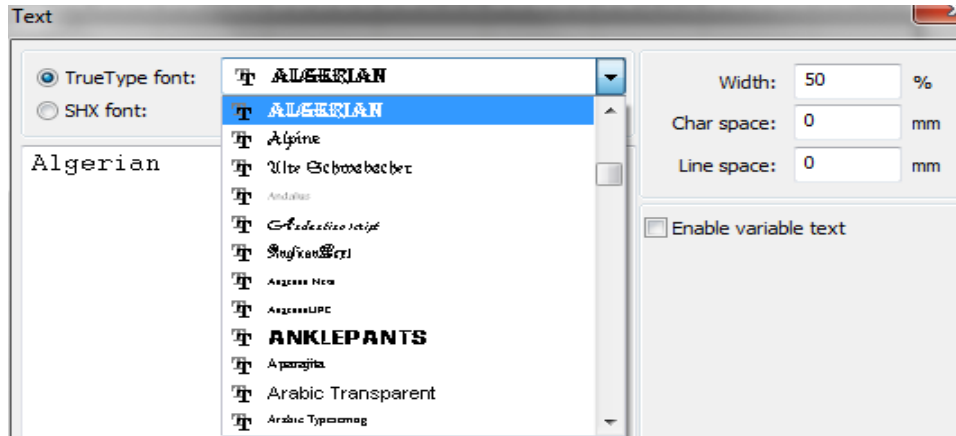
**Rectangles (Ctrl+4) :** To draw rectangles, do the following steps:

Click on menu [**Draw**] -> [Rectangle], or click the Edit Bar icon  to select the rectangle tool. Left click and hold in the processing area to create the starting node of the rectangle. Drag while holding the left mouse button down to expand the rectangle. Release the left button to end the rectangle and exit the tool. Press and hold the "Ctrl" key while dragging the mouse to **draw a square**.

**Ellipses (Ctrl+5) :** To draw ellipses, do the following steps:

Click on menu [**Draw**] -> [Ellipse], or click the Edit Bar icon  to select the ellipse tool. Left click and hold in the processing area to create the starting node of the ellipse. Drag while holding the left mouse button down to expand the ellipse. Release the left button to end the ellipse and exit the tool. Press and hold the "Ctrl" key while dragging the mouse to draw a circle.

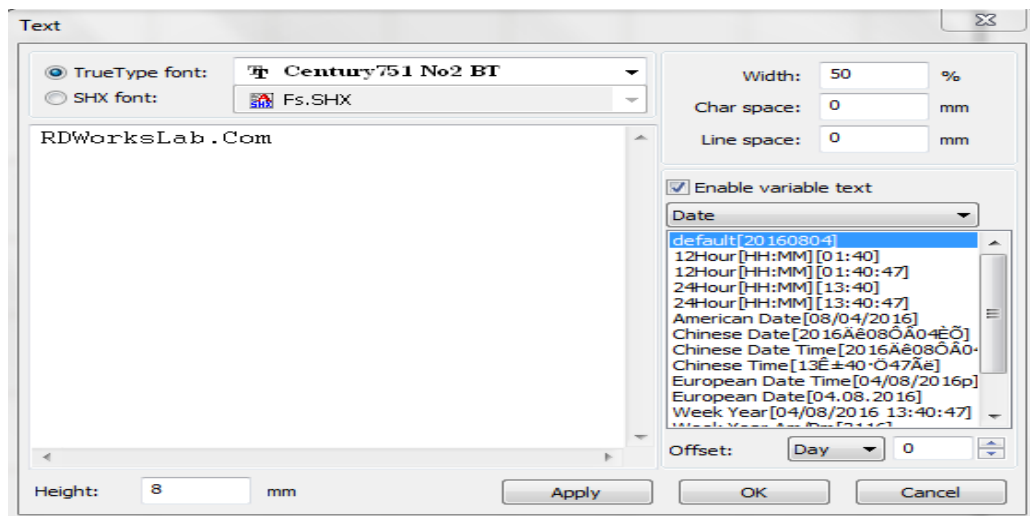
**Text (Ctrl+6)** : To add text, do the following steps: Click on menu **[Draw]** -> **[Text]**, or click the Edit Bar icon  and then click on the screen where you want to insert the text. Enter text, select font, set text height, width, and spacing in the pop-up text dialog box (as shown in **Figure 13**). Click **[OK]** to close the pop-up and apply the text settings. Text remains editable until you select the Un-group Icon  - near Top Left on the Toolbar.



**Figure 11**

In the text dialog box illustrated in **Figure 11**, select the font type from the drop-down menu, and then set the width, height & line spacing. After applying these specifications, click **[OK]**. **Note:** The text in the text selection box **will not appear to be the correct font**, but upon exiting, it will be the correct font on the display.

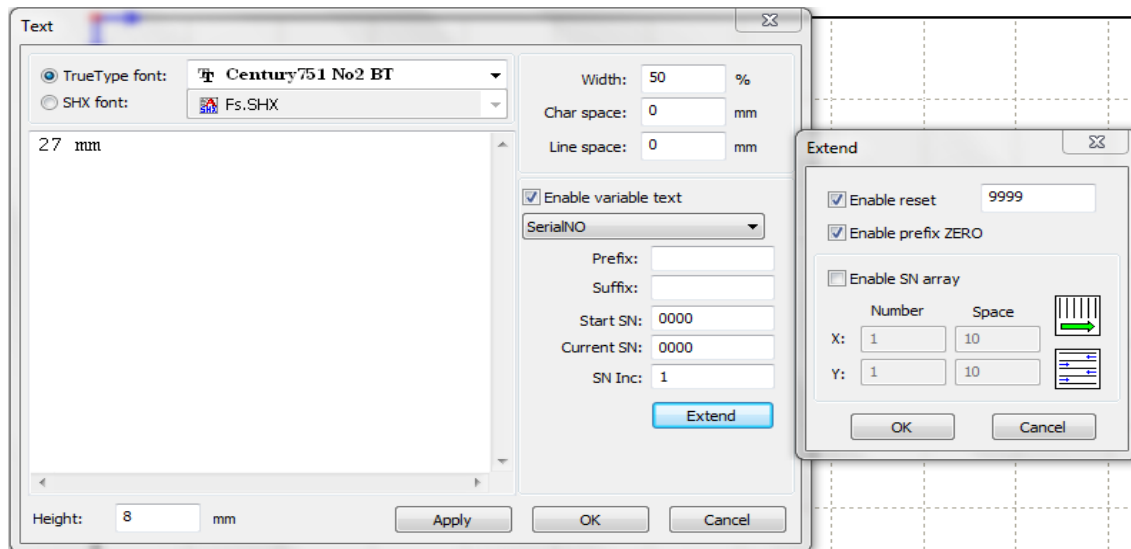
If one enables **variable text** by selecting the Check Box, two variable functions will be revealed: Date and SerialNO (Date & Serial Number) . Each function has its own properties and formats that they must follow.



**Figure 12**

**Select Date:** The date variable text supports 12 & 24 Hour formats and 14 different settings to choose from for Date Display. The time can also be updated automatically from what your PC is set to. Just be sure that the format is the same for both cases.

**Select SerialNO:** (Serial Number) As used in packaging, engraving the expiration period or date can be used on the product. Example is if ABC0001DEF processes repeatedly, ABC0002DEF, ABC003DEF until ABC9999DEF, this is a group of serial numbers.



**Figure 13**

**[Prefix]:** serial number prefix, example ABC is the leading (prefix) string.

**[Suffix]:** the serial number of the suffix, example DEF is the (suffix) string after.

**[Start SN]:** the specified number to start manufacturing, example is to start at 0001 serial number. Using 1 will only allow one digit before being reset to 1 again. Using 0001 will allow up to 9999 before being reset, depending on the [Enable Reset] setting.


**[Current SN]:** the current processing serial Number. It can be used to specify the current processing serial number. When processing a group of serial numbers, in some cases a group of serial numbers require repeated processing, namely to a serial number, then it needs to go back to the [Start SN] (start serial number) to restart manufacturing.


**[SN Inc]:** the interval number can be a prescribed sequence number. The example will process from 0001 to 9999 serial number, the increment is 1. If the number needs to output only even or odd numbered serial numbers, then set the increment to 2.

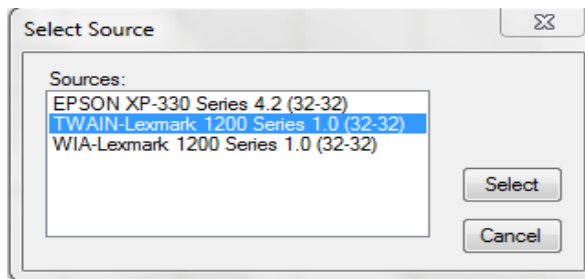
**[ Enable reset]:** when the serial number reaches the reset number, the [current SN] will be automatically reset to the [start SN] .  
Example: if you require repeated processing serial Numbers, from 0001 to 9999, then 9999 can be designated as the reset number. When the serial number reaches 9999, the serial number text will automatically change back to 0001, providing [Enable prefix ZERO] is enabled.

[ **Enable prefix ZERO**]: if not enabled, the system will automatically remove the leading zero(s) in the serial number. Example: serial Numbers, if enabled, then the serial numbers leading zero(s) will be ABC0001DEF but, if not enabled, it will become ABC1DEF. But it is worth noting that, if we want to output the serial number ABC1DEF, ABC2DEF until ABC9999DEF, we can't do this through the [start SN] by setting it to 1 to achieve this, as it must be done by canceling the [Enable prefix ZERO] to achieve. This is because setting the specified number from the [Start SN] specifies the number of significant digits, used to begin to serial number. So, if the number is set to 1, the change in the serial number order is: 1,2,3,4,5,6,7,8,9,0,1,2,3,4,5... The serial number won't change to 10, because the serial number had only one place holder, whereas 0001 has four place holders.

[ Enable SN array]: used for one-time processing more serial numbers, for instance:  
 0001 0002 0003 after this batch is processed, then, 0115 0114 0113  
 0006 0005 0004 skips directly to the next group of 0007 0008 0009  
 0016 0017 0018 or do these numbers two times 0016 0017 0018

**Point (Ctrl+7):** To draw points, do the following steps:  
 Click on menu [Draw] -> [Point], or click the Edit Bar icon  The point will not be processed by the laser but it will affect the start point (green dot).

**Capture / Twain Import (Ctrl+8):** To Capture or Import from Twain, do the following steps:  
 Click on menu [Draw] -> [Capture], or click the Edit Bar icon  If the computer has been connected to a Twain Compatible scanning device, a dialog box will appear. This dialog box enables the user to import pictures from a specified device as shown in **Figure 7**.




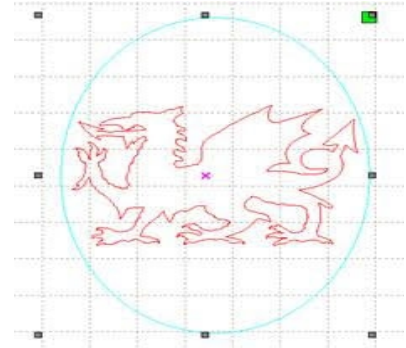
**Figure 14**

After selecting the scanning device, the pictures from the specified device are imported into the drawing area.

## 2.7 Object Selection

The first step in drawing and editing graphics is the selection of the initial object. This can be done by clicking on it while in the Selection mode. An x-shaped mark will appear in the center of the selected object, which will also be surrounded by eight control points (as shown in **Figure 17**). Click and drag any of these points to re-size the object. Drag diagonally to change height and width at the same time.

Click on menu **[Draw]** -> **[Select]**, or click the Edit bar  icon to switch, to "Select." status. This status enables the user to select an object. Objects may be selected in five different ways:



**Figure 15**

- 1) Click on menu **[Edit]** -> **[Select All]** (Shortcut is Ctrl+A) , and select all objects;
- 2) Click on the screen to select a single object;
- 3) Select an object by left clicking and dragging the cursor diagonally over the object, creating a graphic select box that encloses the object. As long as the box fully encloses the object, it will be selected;
- 4) Use the "increased select object/minus select object" process, which includes the following steps: Increase select: Press "Shift" key, click or box select to increase select object. Minus select: Press "Shift" key, click or box to deselect the selected object.
- 5) Select the object according to layer. To select an object according to layer, right-click the selected layer to select all objects in that layer (as shown in **Figure 9**). Does not work with grouped objects.

Layer	Mode	Speed	Power	Output
	Cut	100.0	30.0	Yes
	Cut	100.0	30.0	Yes
	Cut	100.0	30.0	Yes
	Cut	100.0	30.0	Yes

**Figure 16**

### 2.8 Object Color

The color of an object is the color of the objects outline. You can click the color button on the Layer Bar to change the color of the object that has been selected. The color of the pressed button will make the current layer that color. Also, anything created from that point on will be that color. If you import a file with colors, they will be added to the work layer but not to the color bar. Color Bar colors are RGB colors.



Figure 17

### 2.9 Object Transformation

Transformation refers to a change in the location, orientation or size of an object. Changes to the basic shape or characteristics of an object usually are **not** considered "transformations."



Figure 18

The object transformation menu (Figure 20) – provides a convenient interface for users wishing to change the location, orientation or size of a selected object. The user can mirror and rotate an object within the draw toolbar. The user also can use the Object Properties toolbar to transform objects.

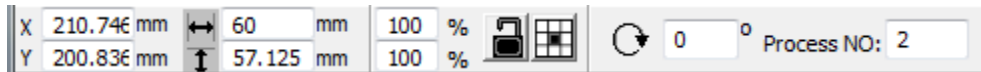


Figure 19

You can also use the [Control Panel] -> [Transform] Tab tools to transform and copy the graphics.

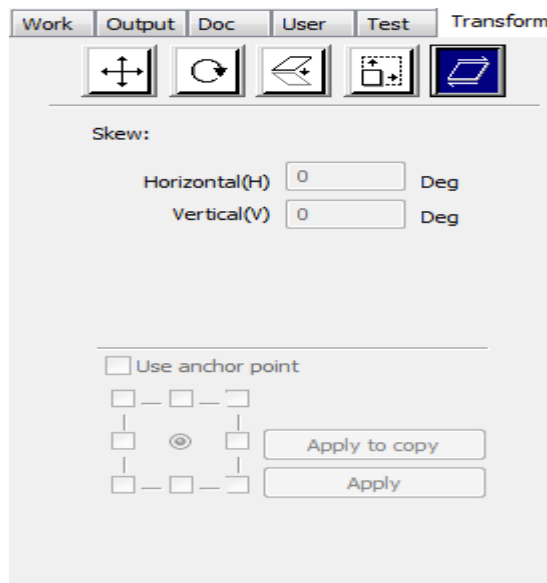




Figure 20

### 2.9.01 Object Flipping

After selecting an object, the object may be flipped about its horizontal or vertical axis by clicking on the horizontal  or vertical flip  icon, respectively on the drawing tool bar.

Images may also be flipped by using the transformation tool (shown in **Figure 20**) to mirror and copy either the horizontal or vertical aspect of the object.

### 2.9.02 Object Rotate

Referring to **Figure 21**, an object can be rotated by first double left clicking twice anywhere on the object, and then by clicking on the appropriate corner icon and rotating clockwise or counter-clockwise.

To drag rotate, move the cursor to a corner  and then press & hold the left mouse button key.

Drag the cursor to adjust the angle of rotation. Note that the rotating wire-frame outline will accompany the dragging process.

The user can enter the precise angle of rotation in the Object Properties toolbar (**Figure 19**), positive numbers are counter clockwise and negative numbers rotate clockwise. You may also use the spin rotation transformation tool (**Figure 20**) to set and lock the center of rotation.

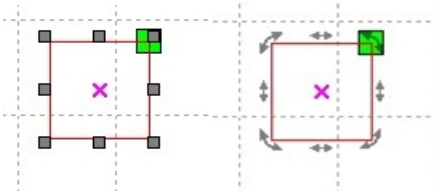
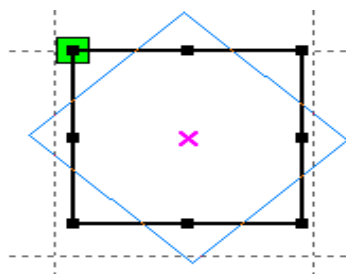


Figure 21



This only works properly for Vector Objects. If you try to rotate a bitmap picture it will rotate in 90 degree increments.

Figure 22

### 2.9.03 Object Size

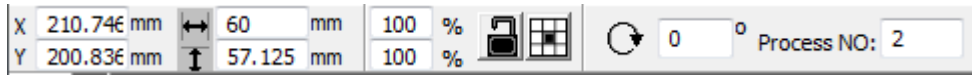


Figure 23

The screen captures above and below show how one can adjust the size and positioning of a

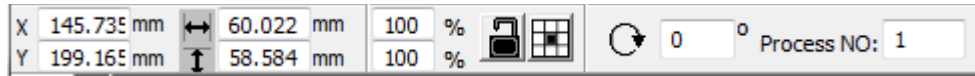


Figure 24

selected object. Size can also be changed by using the size transformation toolbar. This toolbar can be used to modify the size, to lock or unlock the aspect ratio, and to set the position relative to the object being modified. By clicking on the padlock, so the padlock is locked, one locks the size ratio such that if the X size is changed, the Y size will change proportionally with X. The same can be said for the % change. If Y is changed by 50% then X will be changed by 50%. The Icon to the right of the padlock positions the object to one of 9 positions. The default position is centered. Should one position elsewhere, the left hand X and Y positions will be reflected the selected edge position.

### 2.9.04 Object Tilt (Skew)

An object can be tilted by the tilting transformation tools (Figure 15). It can set the tilt anchor and the tilt angle. The tilt will cause distortion of the object and the practical application is for only a small object or portion of an object. Currently it only supports the tilt of vector graphics.

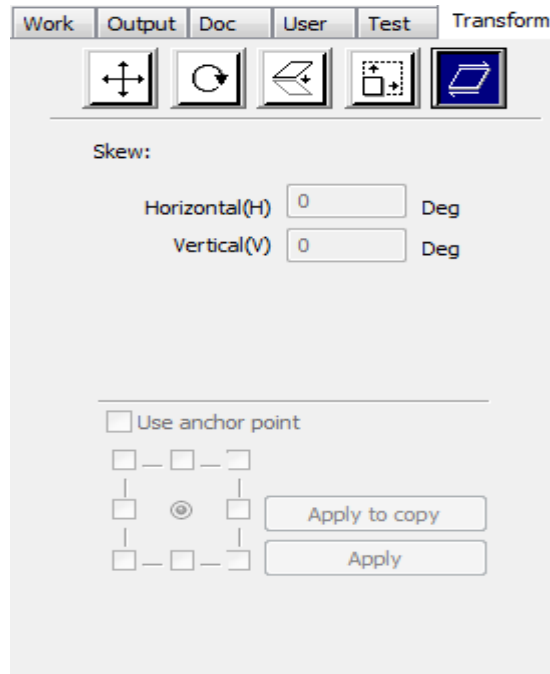


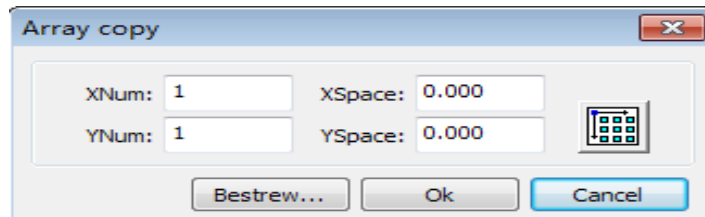
Figure 25



### **2.9.05 Object Array Replication**

To replicate objects, select the object to be copied. The user then opens the "Array copy" dialog box (Figure 28) by clicking the icon.

Click on Bestrew (Distribute) and it will array as many copies as the X and Y size is set for. You must set the X offset space and the Y offset space. **Note: Bestrew = Distribute**



**Figure 26**

The user can replicate an array in different directions. The direction of copying is based on the original graphics. If the user chooses "lower right" as an array direction, the original graphic will appear in the upper left corner. Similarly, if the user chooses an "upper left" array direction, the original graphic will appear in the lower right.

After setting the array number and array spacing, the user can click the [OK] button to see the actual graphics array.

There are two forms of array spacing; center spacing and edge spacing. To choose center spacing, the user must use the [X Distance (mm)] function to define the horizontal distance from the center point, and the [Y Distance (mm)] function to define the vertical distance. Alternatively, the user can use edge spacing, in which the [X Distance (mm)] and [Y Distance (mm)] functions represent the horizontal and vertical distances from the edge of the graphic. In this connection, it is useful to remember the following two relationships:

Center distance X = Edge distance X +  $\frac{1}{2}$  width of object

Center distance Y = Edge distance Y +  $\frac{1}{2}$  height of object


These relationships allow quick conversion from one orientation to the other.

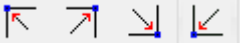
#### **Note: Bestrew = Distribute**

By clicking the [Bestrew...] (Distribute...) button, the user can make the software calculate the array number according to the size, width, height, X distance, and Y distance of the work piece.

### **2.9.06 Placing the Object Relative to the Origin**

RDWorks provides the following tools to control the placement of a selected object:

Clicking the  icon results in the placement of the object in the center of the page, such that the center of the page and the center of the object overlap.

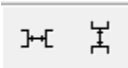
The use of the  icons causes the selected object to be placed in one of the upper or lower, right or left hand corners.

## 2.10 Object Alignment

The precise alignment of objects can be determined by making use of the tools provided by the Alignment Bar. The specific functions invoked by the icons on the Alignment Bar include the following:



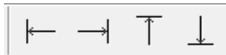
- From left to right, these icons cause left alignment, right alignment, top alignment, bottom alignment, horizontal center alignment and vertical center alignment.



- From left to right, these icons cause an object to be placed at a horizontally equidistant point or at a vertically equidistant point. This requires 3 items to be selected. Item will be centered between the furthest items apart.



- From left to right, these icons cause objects to have the same width, the same height, or the same size as the last selected object. This requires two items to be selected. The last item selected is the Benchmark Item and the action will be performed on the item(s) prior to the benchmark item.



- **The purpose of these controls is UNKNOWN at this time.**

**RUIDA has said,** “ These Icons are [of] no use now.maybe it will add some functions in the future. “


**Benchmark Object:** All tools work from the last Object Selected.


If you press the "Shift"key and select objects one by one, then the benchmark object is the last object selected. If you select the object by the select box, then the benchmark object is the object that was the last selected object.


## 2.11 Object View


Roll the Mouse Wheel to **Zoom In or Out** at the Cursor's Location.


**Move:** Click on menu [**Edit**] -> [Move] ,or click  .Then hold down the left mouse button in the drawing area, and drag and pan.

**Zoom Out:** Click on menu [**Edit**] -> [Zoom Out], or click  . With each click, the drawing area will zoom out once. Move the mouse to the drawing area and click. With each click, the mouse is positioned as the center of the drawing area and will zoom out once.

**Zoom In:** Click on menu **[Edit]** -> [Zoom In], or click . With each click, the drawing area will zoom in once. Move the mouse to the drawing area and click. With each click, the mouse is positioned as the center of the drawing area and will zoom in once.

**View Select:** Click on menu **[Edit]** -> [View Selection], or click . Move the mouse to the drawing area, hold down the left mouse button and drag, a dashed border box will show in the drawing area, release the mouse button, then the region in the dashed border box will display enlarged and centered in the drawing area.

**View Page Frame:** Click on menu **[Edit]** -> [View Page Frame], or click . The full page frame will display.

**View Data Frame:** Click on menu **[Edit]** -> [View Data Frame], and click . The selected objects will fill the display area. Note, an object must be selected to enable this icon.

## **2.12 Group and Un-Group**


Groups will cut together. They will not select with Right Click on Color. When used in conjunction with the [Edit] -> [Set cutting properties] feature as described in Section 2.13, there are powerful benefits to be had. See:

[https://www.youtube.com/watch?v=\\_3oUQ9gKjCk](https://www.youtube.com/watch?v=_3oUQ9gKjCk) Another extremely useful feature of this

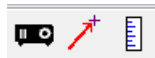
function is for manipulation, and justifying, text. See: [https://www.youtube.com/watch?v=\\_NluzdiikNg](https://www.youtube.com/watch?v=_NluzdiikNg)

Often times various individual graphics must be grouped together, or un-

grouped, for one operation or another. Grouping and un-grouping is accomplished by

selecting a group of graphics, or a previously grouped aggregate of objects, and then Click on menu **[Edit]** -> [Group] or Click on menu **[Edit]** -> [Un-group], or by clicking the group or un-group icons  on the toolbar.

### **2.12.01 Additional Tools**



These tools are additions in V8.01.19.

#### **Projector:**

Allows adjusting a projector. As we do not have one, we can not comment on this.

#### **Docking Point:**

Allows you to set a return to point after a job. This point is a absolute position from your machines home location. I set mine to X200 Y0. But if all you do is give it a docking point, it still returns to the start location of your part by default. So we need to go into user settings and make a change.

Make sure your computer is plugged into your laser, and the laser is on. Then in RDWorks, go to your User tab. And click "Read" at the bottom. This will load your machines user settings. Now you need to scroll down to the "Other" section and find the option for return position. It should read Absolute Origin. Change it to "Not Return". Now click write, to upload the changes to your machine.

Now your machine will return to this given location after each job. It will retain this position between part files and sessions as well. And of course you can change it, or turn it off as well.

See <http://rdworkslab.com/viewtopic.php?f=3&t=505>



**Measure Tool:** To use the measure tool , click on it, then in the display area, left click and release to set the datum point. As the pointer is moved, the distance from the datum to the pointer is displayed on the information bar at the bottom of the screen. Left clicking again terminates the measurement tool and statically displays the distance between the datum and the second selected point. The measurement displays on the bottom bar towards the right hand side.

### **2.13 Important Tools**

The following tools can be used to optimize the order and direction of object processing.

#### **2.13.01 Manual sorting and setting of the cutting point and cutting direction**

RDWorks provides users a convenient tool for the manual sorting of graphic objects. To make use of this tool, the user should Click on menu **[Edit]** -> **[Set cutting property]**, which will invoke the cutting property dialog box (**Figure 13**). This dialog box can be used for manual sorting and the setting of cutting points and cutting order.

The Arrow works as a "Lock Button".  If the button is not pressed, when you place your cursor on the page being ordered, you can drag the page around. If you press the "Arrow Button" you will not be able to move the picture around. If you scroll the picture, it will zoom In and Out regardless of the "Lock Button". Now, your picture may not be centered or wholly view-able in the window. Press the  Button and regardless of the lock arrow, the picture will be re-sized and centered in the window.

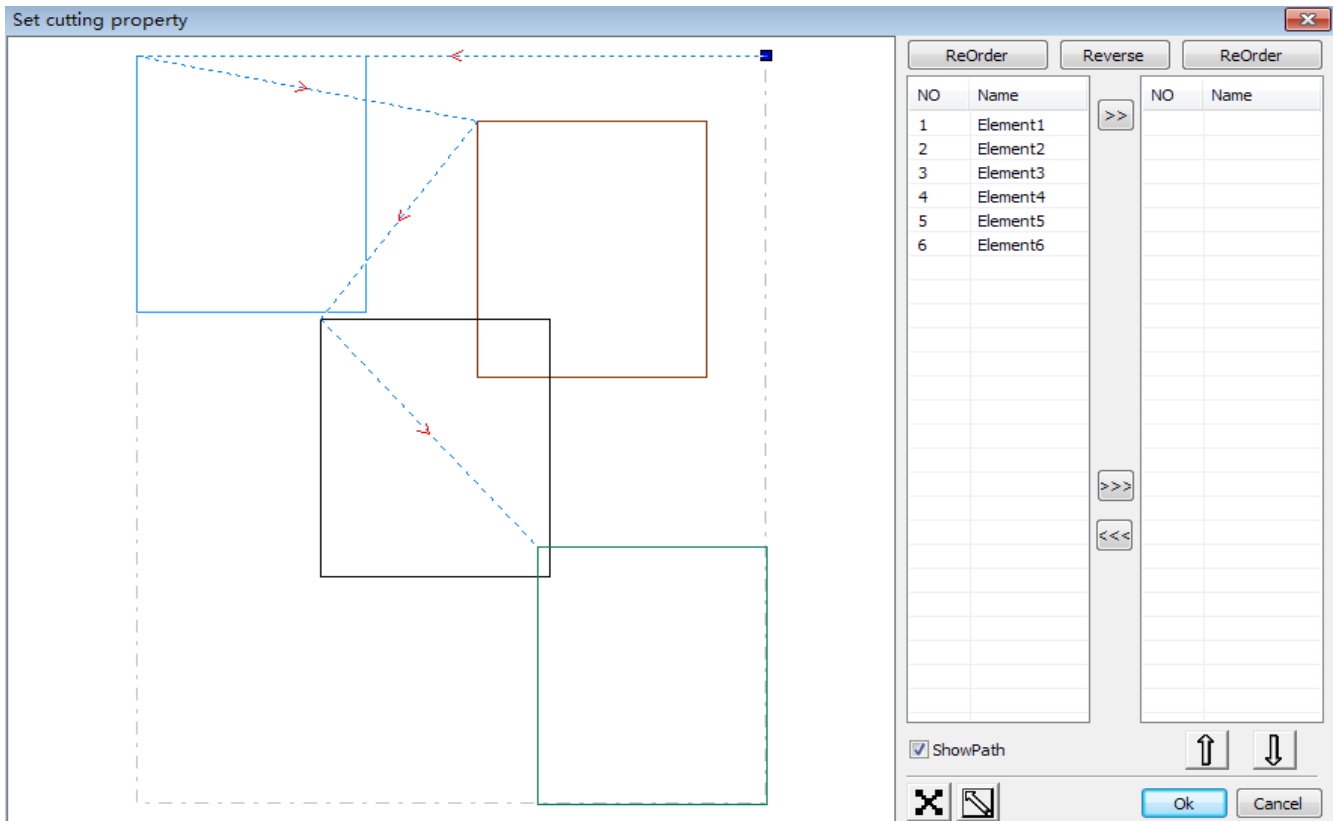








Figure 27

**Show path:** By checking the "Show Path" button at the bottom right of the cutting properties dialog box, the user can see the current graphics cutting order and the cutting direction.

**Manual sort:** By selecting the "Lock" icon,  (see Figure 27) the user can switch the current status of the operation between view and edit. The user can then highlight or click the objects in the object display area. After selecting an object, the user should select the  icon to have the graphics redirected to another list where they can be re-ordered. Continue selecting and pressing the  icon to move another object to the right hand column to re-order the laser sequences. A sequence of operations is then performed on the objects before the selection is completed. To change the direction of graphic processing, the user should first select the targeted graphic in the graphics display area or in the list, and then click  the Reverse button. If the work area contains vector and BMP images, no matter where you place the BMPs in the processing order, they will ALWAYS be processed before vector objects. The order of objects may be raised or lowered by using the  and  arrows when an object in the right hand column is highlighted.

Use the preview window to check processing order before saving to U file.

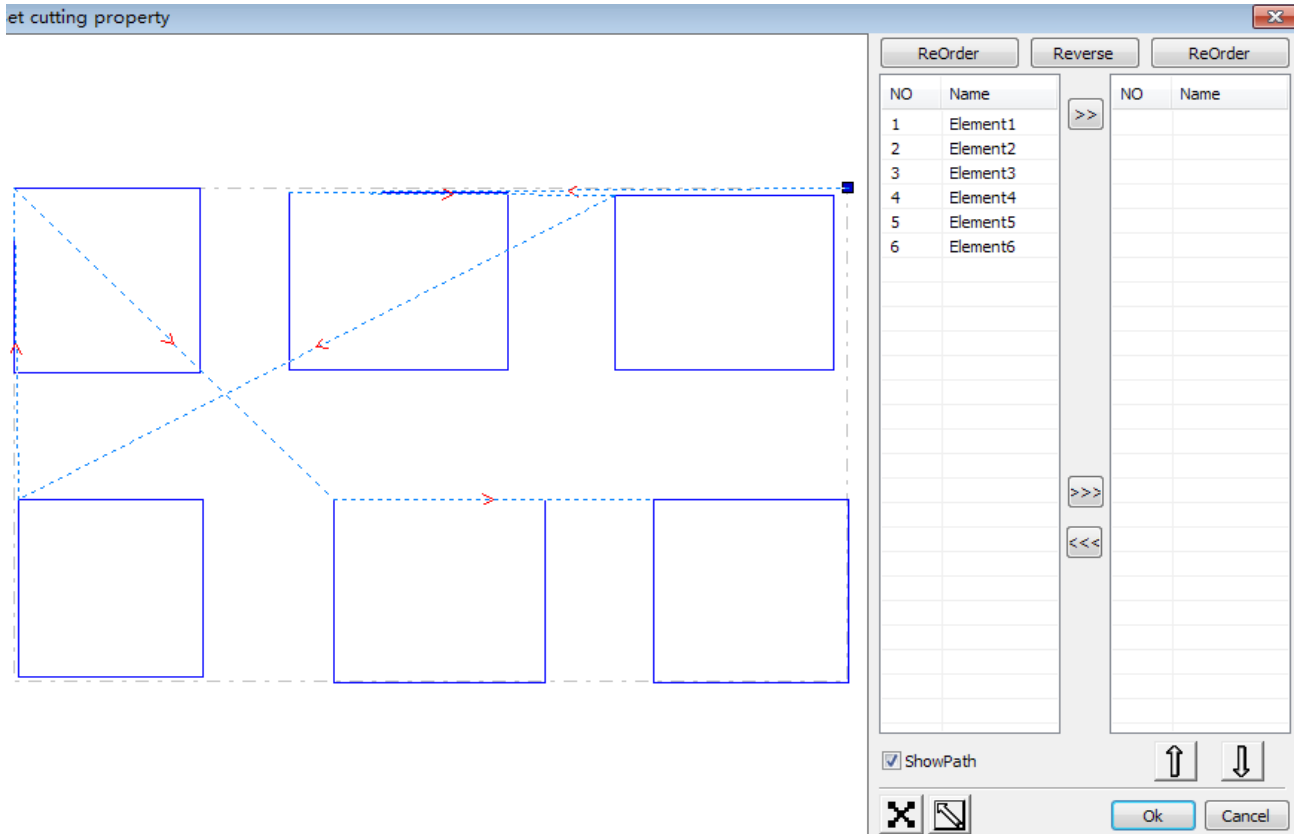





Figure 28

To change the cutting order, first select the graphic and then inspect the nodes in the display area. If in “Edit mode” using the Lock Icon , a new node can be selected as the starting point by double-clicking the mouse on it. This is within each separate box, not between boxes. After all changes have been completed, click on  to save the changes.

In addition to cutting property features, RDWorks also offers tools to change the cutting order, cutting direction and cutting start point. To do so, select the  icon in the toolbar, or click on menu [Edit] -> [Show Path].

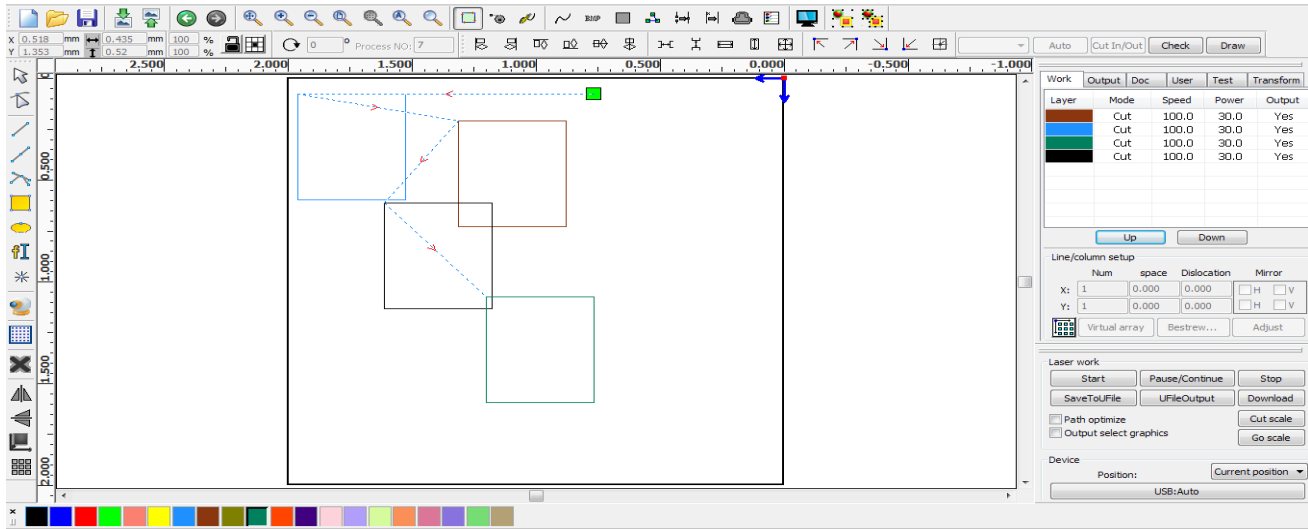


Figure 29

Choose the object that should have the cutting order changed, and the **Process NO: 2** process number of the current primitive will display in the object properties bar. Another method to change the cutting order is to enter the cutting number directly in the Processing number box, and then press the keyboard "Enter" key, or click the plot area.

**Changing Graphic processing direction:** To change the processing direction, click **[Edit] -> [Set cut direction]**. Then you can double-click on any position of the selected graphic. A small red arrow on one of the objects nodes will change direction to indicate the direction the object will be processed.

**Changing the cutting point:** To edit the cutting point, click **[Edit] -> [Set cut point]** to enter the "Change cutting point" mode. To select the curve to be edited, double-click on the node identified as a new cutting point.

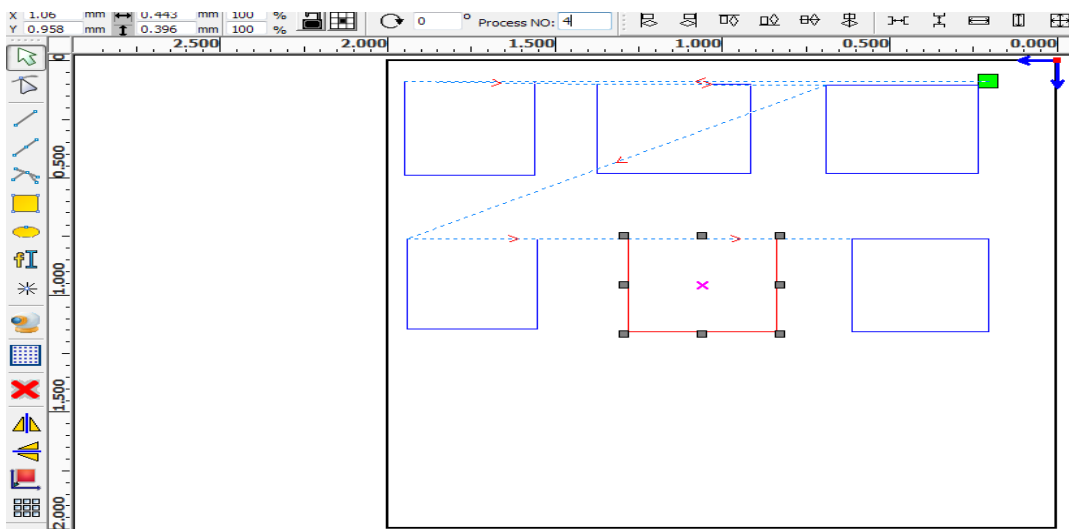

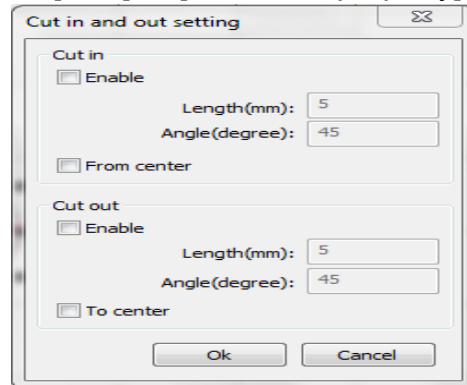


Figure 30

### 2.13.02 Setting And Editing The Cut In/Cut Out Lines

This is very similar to lead in and lead out in CNC machining. For most cuts this feature is not needed. By default, a drawn or imported curve does not have any cut in/cut out lines. To add such lines, select the objects and then invoke the "Cut in and out setting" dialog box (see **Figure 31**) by Clicking on menu **[Edit]** -> **[Edit cut in property]**, or by clicking the  icon.



**Figure 31**

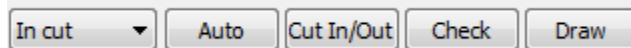
To make cut in/cut out lines, the user must first enable the cut-in/cut out function. Straight line cut-ins are created in three ways:

- By cutting in at an angle. In this procedure the cut in line and starting segment form a specified angle (in which counterclockwise angles are positive) and ~0 to ~180 degrees are usually inside the graphic.
- By cutting in at the center, and by making the starting point of the cut-in line at the center; and
- By cutting in at the center, drawing the cut-in line from the center to the starting point, and by assigning it a specific length.

With the "Cut In - Enable" check box selected, the laser will curve in to the selected edge tangent to the direction of the vector at the point it actually reaches the edge. Checking the "Cut Out - Enable" box results in an exit lead being added to the path at the end of the path, off the cut edge. The "Length:" and "Angle" require setting.

The processing of setting cut out lines is the same as setting cut in lines.

Clicking on menu **[View]** and selecting "Cut In/Out Bar" will give you the control in figure 35.



**Figure 32**

With a selected object, you are able select "In cut" or "Out cut", "Auto", select dimensions and direction as in the description above, using the "Cut In/Out", Check the drawing and Draw the Cut In or Out. See "**Kerf**" for an additional use for this bar.


**We have no real use for this as Cut In/Out as it is not required with our low powered lasers. High power metal cutting lasers might be able to make use of it.**

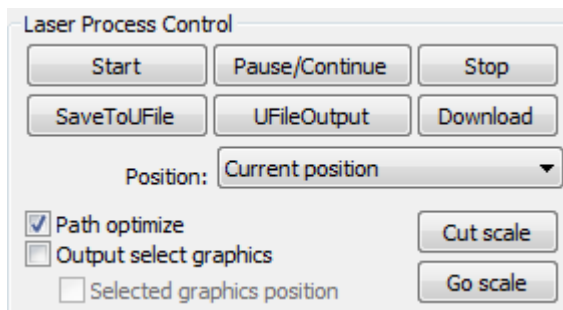


### 2.13.03 Path Optimization

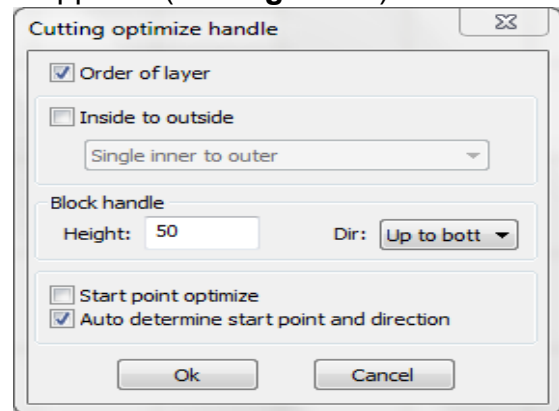
Path optimization relates primarily to the re-ordering of vector graphics.

Note. At the bottom right of screen just below the “SaveToUFile” button is a path optimize check box (see **Figure 33**). If this is ticked it will override and mess up the choices you have made in the Cutting optimize handle window . **UNTICK IT**.


To begin the path optimization process, click on menu [**Handle**] -> [Cut optimize], or click the  icon, and the “Cutting optimize handle” dialog box appears (see **Figure 34**) .



**Figure 33**



**Figure 34**

To view the cutting path before and after processing, the user should Click on menu [**Edit**] -> [Show Path], or click the  icon. The graphics cutting path always starts from the laser head. Objects which are Grouped are cut together – Grouped inside objects are cut first IF selected first, then the outside objects are cut. Path optimize needs to be unchecked, or it will not cut as shown.

#### **Cutting optimize handle:**

**Order of layer:** if checked will cut using the order of the layers.

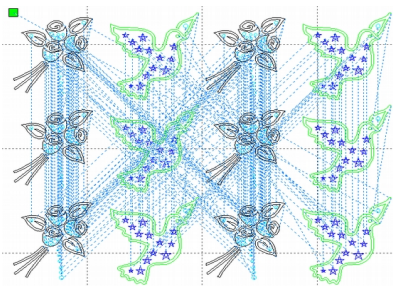
**Inside to outside:** if checked will cut from inside to the outside.

**Block handle:** Height will include those items that are within the entered distance as preferred cutting objects. Items further away will be cut later.

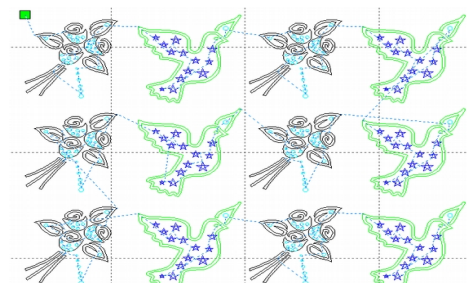
**Dir:** Selects one of the four start areas and direction of cutting.

**Start point optimize:** if checked will try to determine the optimum start point.

The effect of all of these selections can be seen if “Show path” is selected.




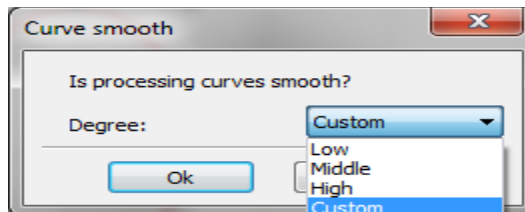
Before Processing  
**Figure 35**



After Processing  
**Figure 36**

### 2.13.04 Curve Smoothing

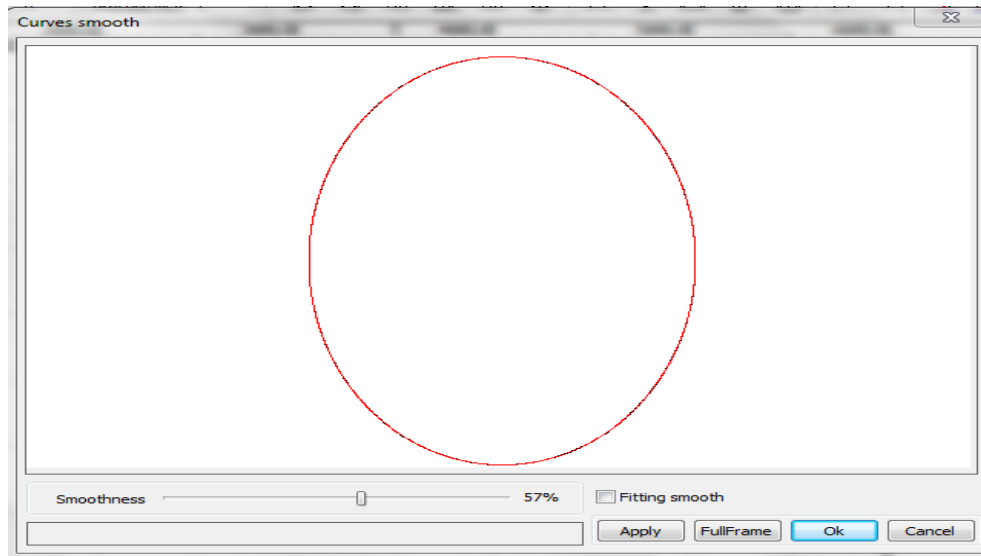
For curves that do not require a high degree of precision, the curve smoothing function can be used to make the curves appear smoother and to speed up processing. To invoke curve smoothing, the user should Click on menu **[Handle]** -> **[Curve Smooth]**, or the  icon. These keystrokes invoke the curve smoothing dialog box (see **Figure 37**) .



**Figure 37**

Select Low, Middle, High or Custom.

If Custom is selected you will then see the Curves Smooth Dialog Box. (**Figure 38**)



**Figure 38**

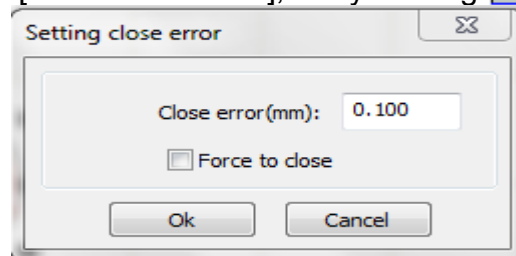
Smoothing is effected by dragging the smoothness slider (at bottom left) to the desired point, and by then clicking the **[Apply]** button. The curves before and after smoothing will be visible in the dialog box; black curves represent originals, red curves represent smoothed curves.

You can zoom in or out of the smoothed curves by rotating the scroll wheel on the mouse. The largest view of the smoothed graphic can be obtained by clicking the [Full Frame] button in the dialog box.

After the desired smoothing effect has been obtained, the [Apply] button should be pressed to save curve smoothing settings.

### 2.13.05 Closure Check


To check closure, invoke the "Setting close error" dialog box (**Figure 39**) by clicking on Menu [Handle] -> [Curve auto close], or by clicking  on the System Bar.

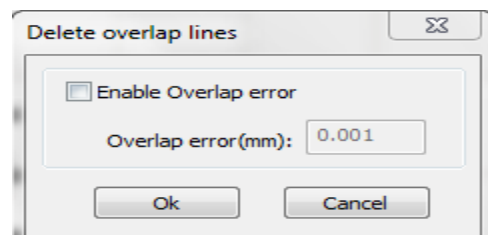


**Figure 39**

Setting the "Close error" defines the distance in millimeters from starting to ending point. When the distance is less than this "Close error" tolerance, the curve is closed automatically. The "Force to close" box forces the closing of all selected curves.

### 2.13.06 Removing Overlap


To removed overlaps, invoke the "Delete overlap lines" dialog box (below) by clicking on menu [ **Handle** ] -> [Delete overlap] or click the  icon.



**Figure 40**

Under normal circumstances the user should not select the "Enable Overlap error" function. This appears to only work if the lines are the same length. It works well with box joints like those produced by <http://www.makercase.com/> if you are using line-to-line fits. Then you can overlay the edges of your panels, use this to delete the overlap and you get the most compact layout and fastest processing possible. If removing overlapping lines does become necessary, it is important that the user not make the overlap error too large in order to avoid accidentally deleting lines that should be retained.

### 2.13.07 Combine Curve

To combine or merge curves, invoke the "Setting combine error" dialog box (below) by clicking on menu [Handle] -> [Combine Curve], or by clicking the  icon.

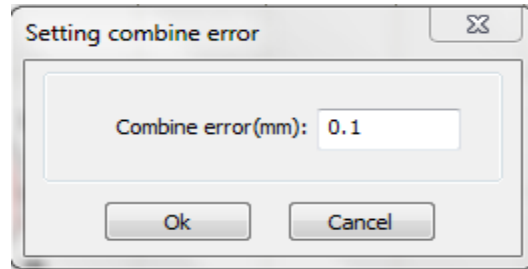



Figure 41

The software automatically merges selected curves when the merge tolerance is less than the value set in the "Combine error" box in millimeters.

### 2.13.08 Bitmap Handle

The Bitmap Handle function sets image characteristics of bitmaps such as size, resolution, brightness, contrast, and color. To invoke the "Bitmap handle" dialog box (below). Load a bitmap to the work space, select it and then click the  icon or Click on menu [Handle] -> [Bitmap handle].

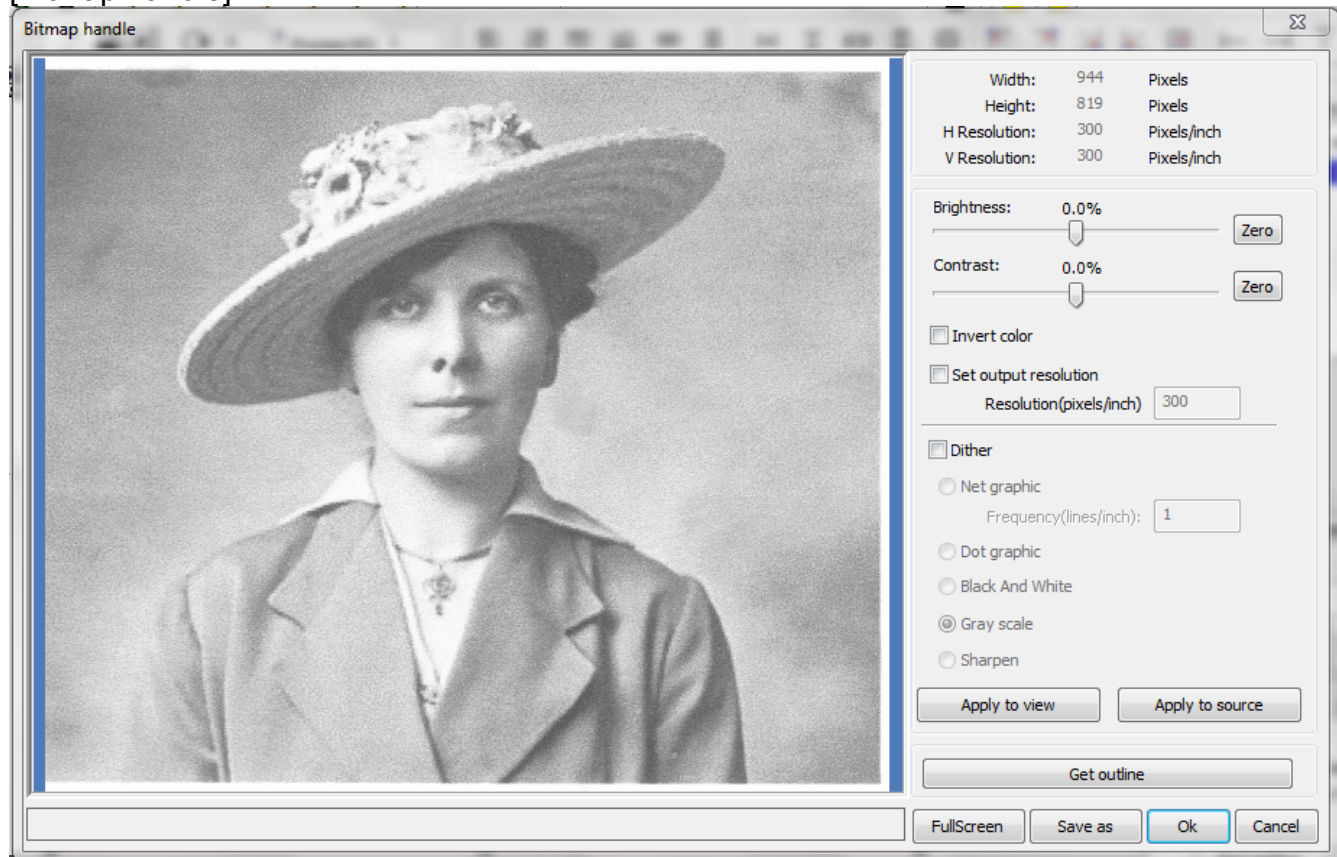


Figure 42

The top right of the dialog box displays the information for the selected image (as shown in **Figure 42**).

Other options associated with this function include the following:

**[Apply to view]**. Until this button is clicked, the most recent changes are only previewed without affecting the original bitmap. Before the [Apply to view] button has been clicked, the [Cancel] button at bottom right of the dialog box can be pressed to return to the original image. Thus, this option is good for trial-and-error adjustments to an image, but it requires more time and memory than other options.

**[Apply to source]**. With this setting, changes are made directly to the source image, and pressing [Cancel] will not restore an altered image to its original state. Therefore this option is mainly used in a multi-step operation, such as transforming general pictures into gray scale. Such sequential processing saves computing time for follow-up operations.

**[Save as]**. This button retains the results of the previous operation, allowing a processed image to be exported/saved to the hard drive. Therefore [Save as] is often used in conjunction with [Apply to view]. In general, use the [Save as] function to facilitate subsequent processing.

**[Gray scale]**. All imported graphics are forced to gray scale mode. You may adjust contrast and brightness to have some auxiliary effect to the graphic.

The following images show an image before and after specific processing functions:

Before Processing

After Processing



Adjust Contrast



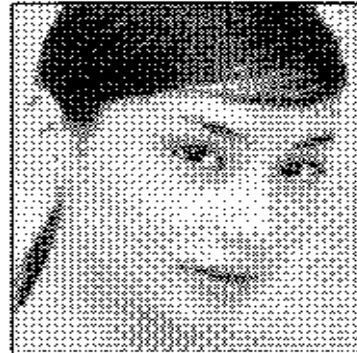
Invert



### Sharpening

There are three methods for dither processing: Net graphic, Dot graphic, and Black and white.

**Net graphic:** This function adjusts net size and is better suited to low resolution material, or when the laser is cutting relatively slowly. To get the appropriate net size, the user can adjust the resolution and net frequency of the image. The higher resolution, the more delicate. The higher net frequency, the smaller the net size, and vice versa. Image resolution is generally set at 500 – 1000 pixels, while net frequency is set at 30-40 lines.



### Net Graphic

#### **Dot graphic:**

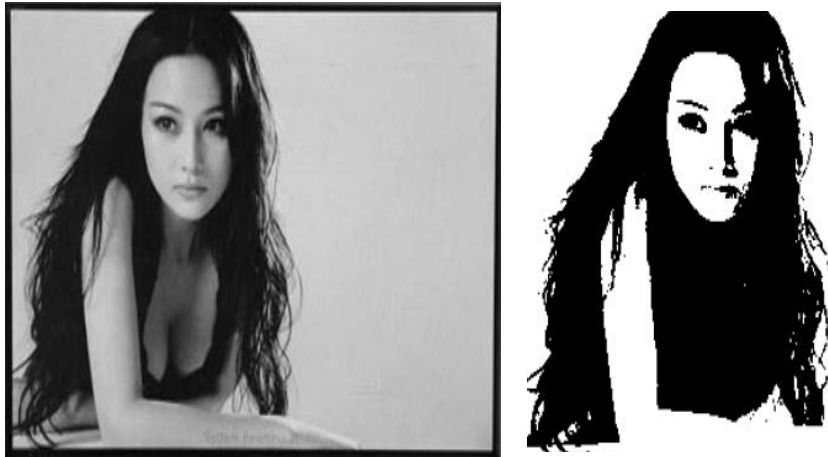
Dot graphic performs well with gray scale images. It is better suited to high resolution images, and to operation in which laser response is fast.



### Dot Graphic

### Black & White:

In most cases, changing color into black and white image produces poor quality images. It is, however, very easy to use for clear outline images.



Black & White

### Get Outline:

Note that the "Get outline" button is found at the bottom right of the "Bitmap handle" dialog box (shown in **Figure 43**). This is an "Auto Trace" function that only works with some sharp edged graphics.

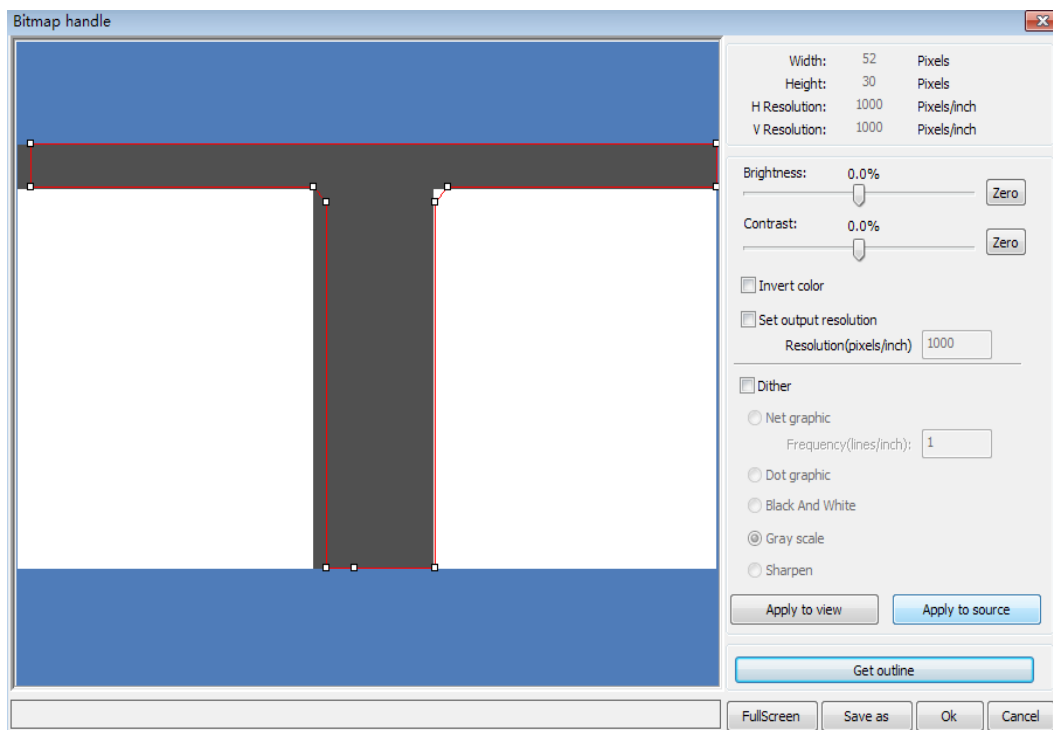

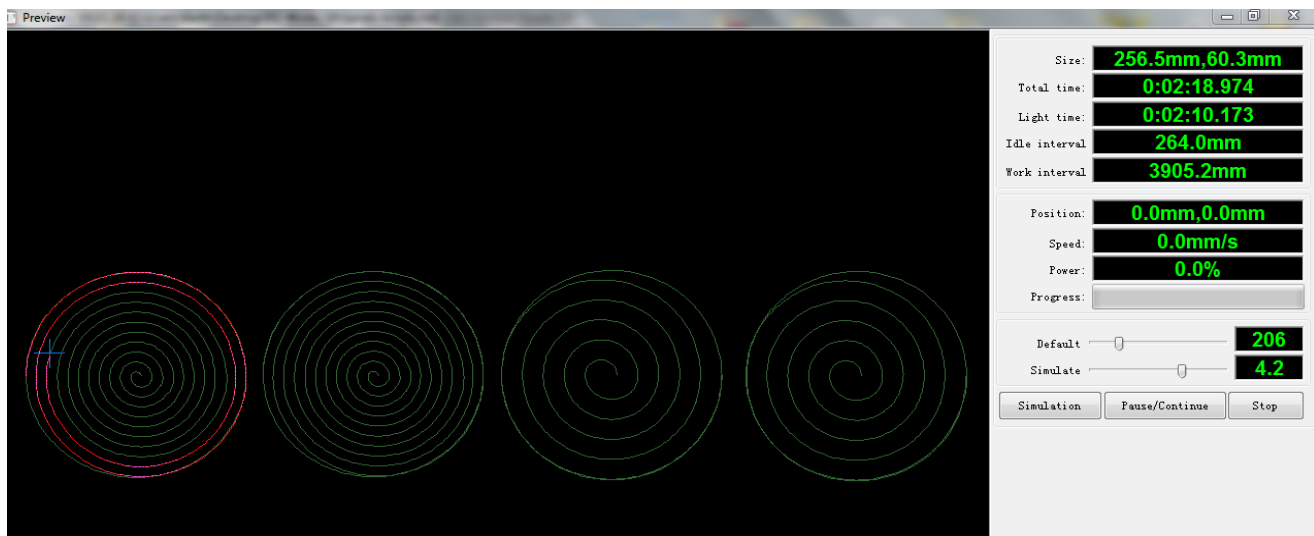


Figure 43

### 2.13.09 Processing Preview

To preview processing, invoke the "Preview" dialog box (illustrated in **Figure 44**) by clicking menu [Edit] -> [Preview], or clicking the System Bar Preview icon .

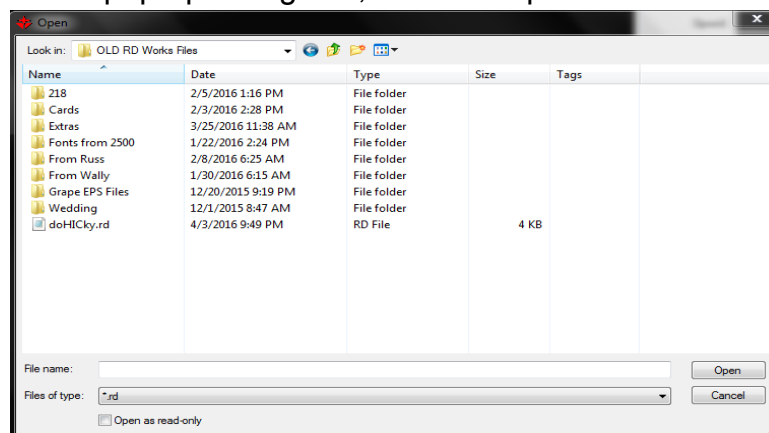


**Figure 44**

RDWorks supports previewing of the documents undergoing processing. The user can get important basic information from the preview. For example, the preview shows the path of the actual output of the processing, the general processing time, and the processing distance. The cutting process can also be simulated.

**Note:** Exiting the Preview Mode before pressing the "Stop" button and stopping the simulation can cause the software to crash if it is a large file.

In addition to the current edited file preview, you can also preview the files that have been saved as rd. To preview an rd file, first double-click in the graphics display area. Choose the graphic to preview in the pop-up dialog box, and then open it.



**Figure 45**

RDWorks also allows parameters to be set during preview. This works with RD type files. To do so, invoke the configuration menu (shown in **Figure 45**) by right-clicking anywhere in the graphics display area. Select "Config" in the pop-up dialog box.



When the preview button is pressed the screen shows a gray scale image of the proposed program, where various shades of gray represent different power settings. When you invoke a simulated cutting cycle the path of the laser overwrites the gray image with a colored line whose color again varies with the programmed power. There is a configuration menu that allows you to change these colors (**Figure 46**).

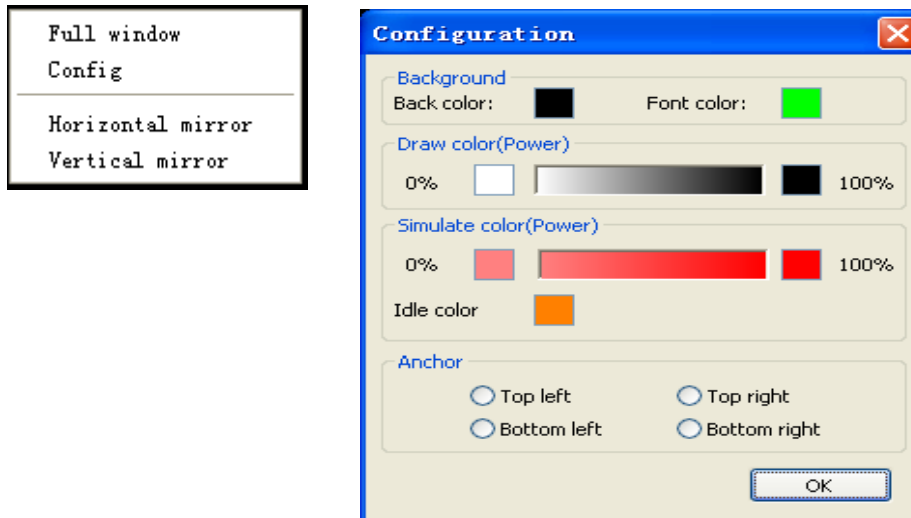



Figure 46

### 2.13.10 Data check

To check graphics data, invoke the "Data check" dialog box (in **Figure 48**) by clicking the menu command [Handle][Data check], or the system toolbar icon 

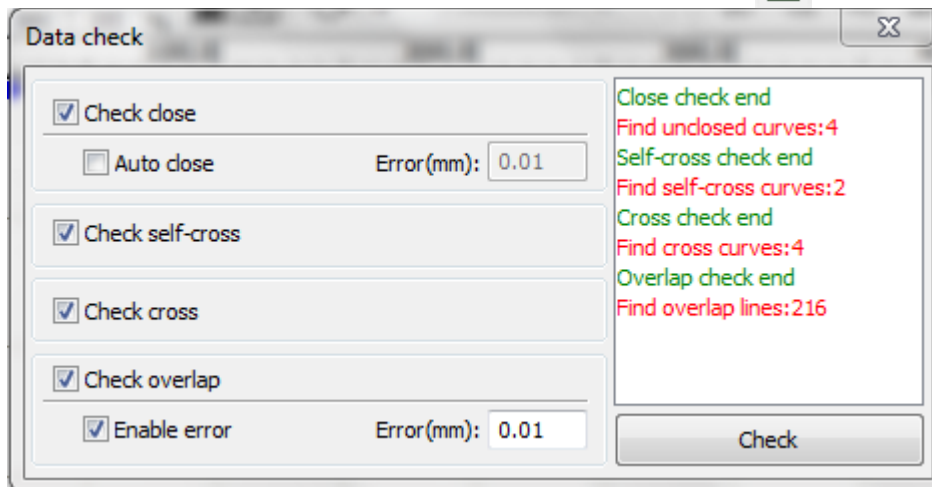



Figure 47

When the user clicks the "Check" button at the lower right of the dialog box, data problems will be shown in the dialog box. The problems/results will be shown in the selected graphics. These graphics should then be repaired. The data inspection process should be repeated until all of the data conforms to the requirements of the processing.

### 2.13.11 Generate parallel lines / Offset

Select to create parallel lines around the graphic, click on the menu commands [Handle] / [Offset poly] , or click the  icon on the system toolbar .

The Red line in the figure is the original selected graphics, the outside Blue line is the outside offset graphics.

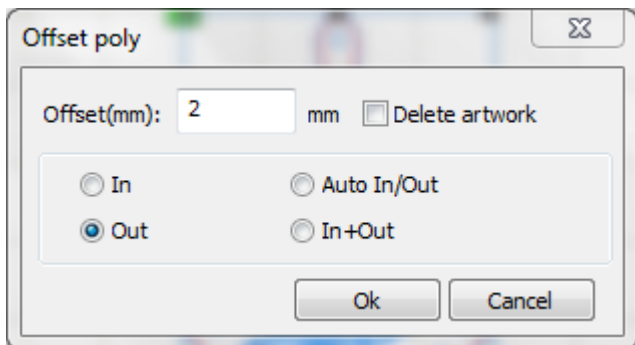


Figure 48

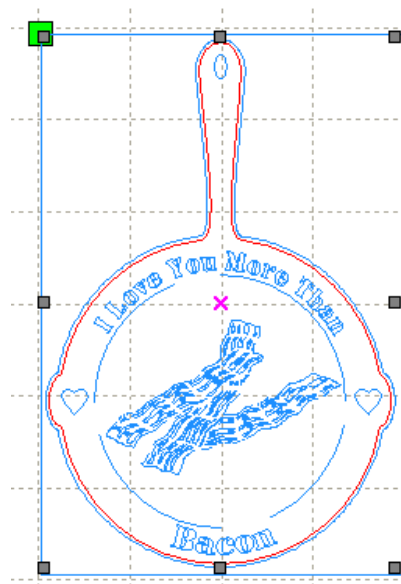



Figure 49

### 2.13.12 LGP design - Light Guide Plate

Click the menu commands [Edit] -> [LGP design ], or click the drawing toolbar  icon, and you can start the LGP design tools, the tools are specific to block the sun reflections as an independent function. If the user does not need to block the sun or to make Edge Lit Signs or surfaces this section can be ignored.

The three Tabs of LGP Design.

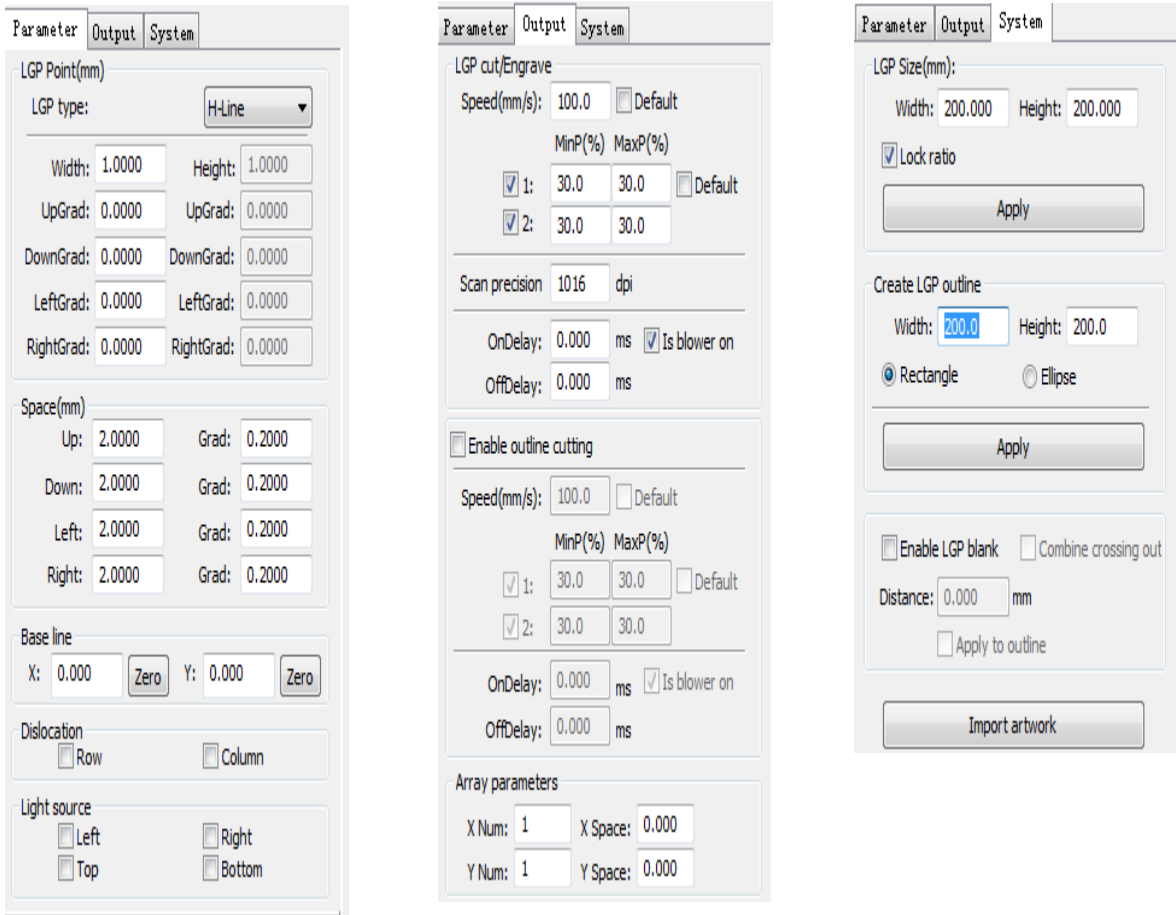


Figure 50

We start with a blank slate and the design tools, we first need to design an outline of the light guide plate. In the tools, the default is 200 x 200 rectangular guide blank slate outline. The user can, using the tools of the "System page" manually create a desired shape for the light guide blank slate outline.

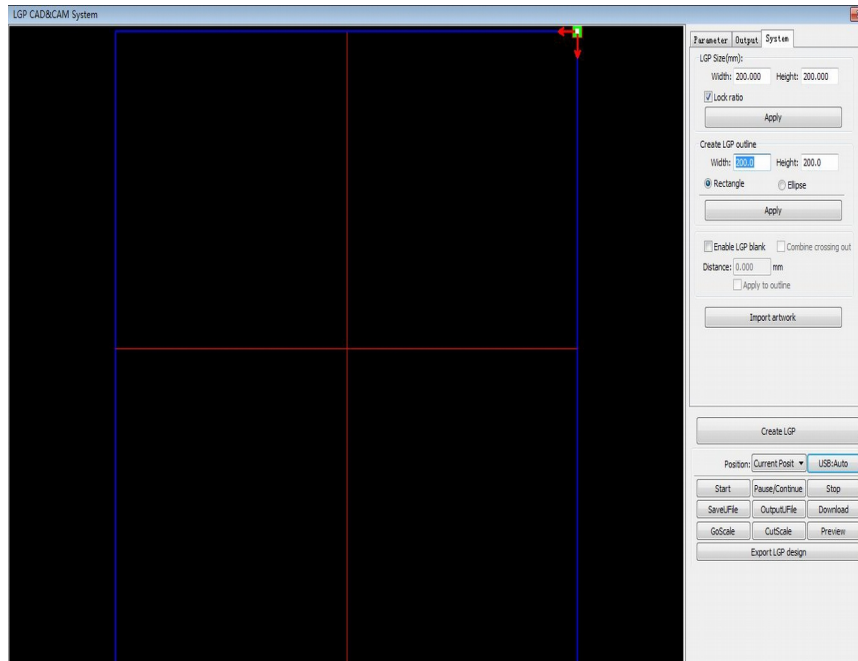


Figure 51

The Software also supports the exporting of the light guide plate design to the RDWorks main program for processing.

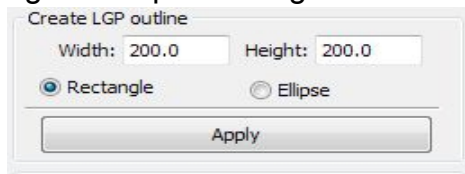


Figure 52



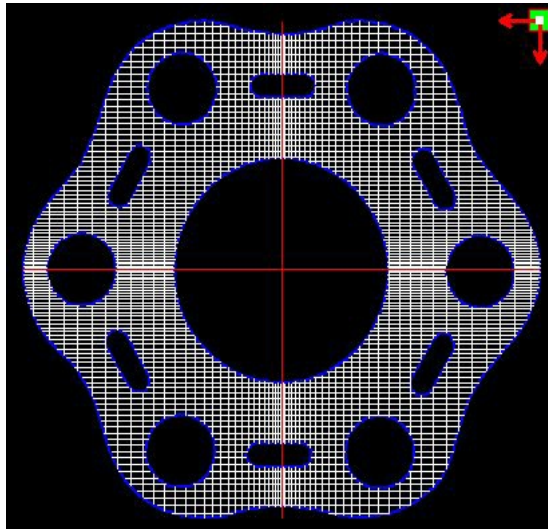
Figure 53

Created using the default setting, the outline can use a rectangle or an oval. The user can also import a good graphic design, to use as the outline of the light. Click on the "Create LGP" button, and you can choose to have the outline of the document as the light. The outline file must be closed graphics, otherwise, the system will automatically delete it.

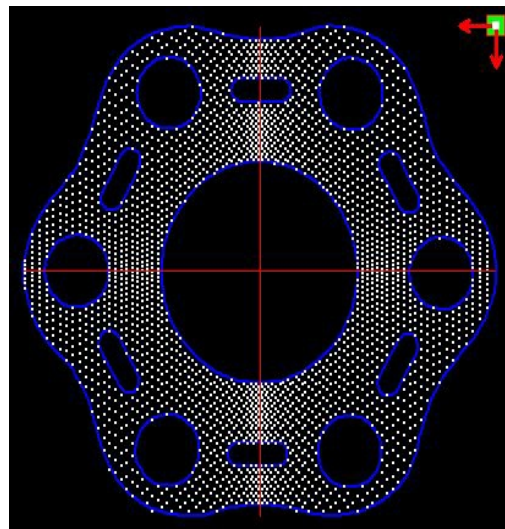
If the outline of the imported graphic is within the size requirements, users can also change the size outline, and can set it up to keep a white edge.

With the Outline graphics, they can start on the blank slate and increase the network. Network is divided six ways: horizontal, vertical line, elliptical, rectangle, reticle and the grid. Baseline is related to the light source, the user can adjust the baseline position according to the light source. In the figure above red graticule marker is the baseline, users can move the

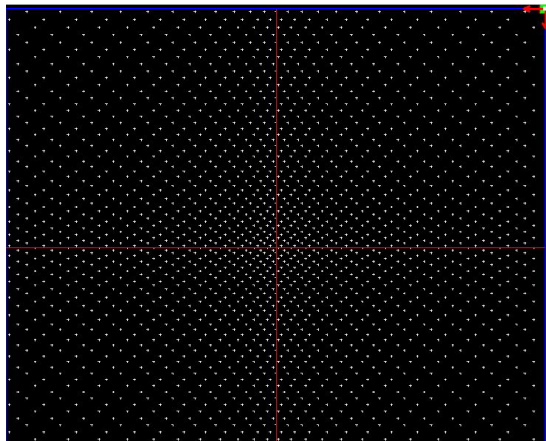
mouse to baseline, press the mouse, and then drag the baseline to desired position. The entire guide baseline reflex is divided into four regions, level above baseline definition for uplink and downlink below is defined as;  
Vertical baseline definition for the left column on the left, the right to define right column. Set the respectively size and spacing for the network in up, down, left column, the right column initial values and the gradient of the change, and users can form the desired effect. For the grid method, one must change the column that will appear on the grid. For the convenience of application, for the system to provide the light setup, if the light source is a standard, you can choose the light source, then set the network parameters, and you do not need to adjust the baseline. At this time, the baseline shows or hides.



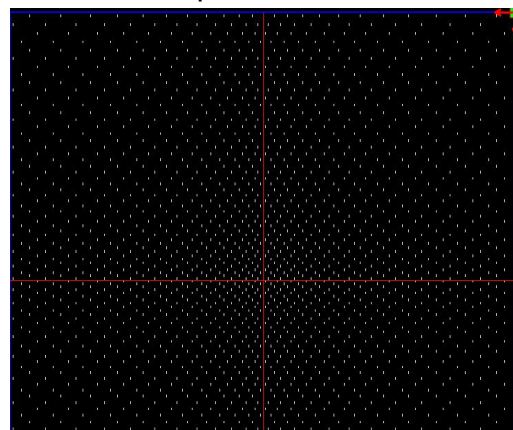
Grid Method



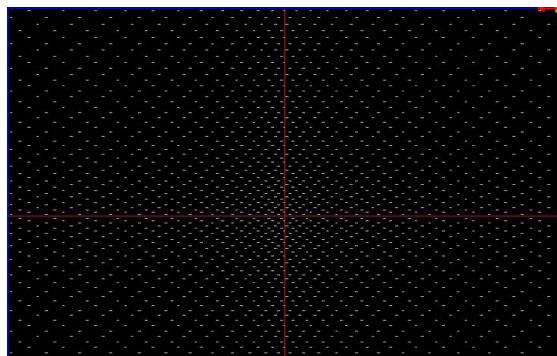
Elliptic Method



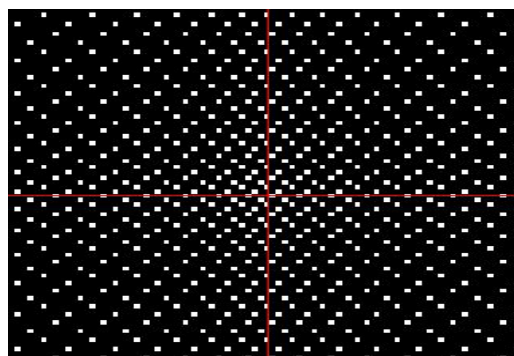
Reticle method



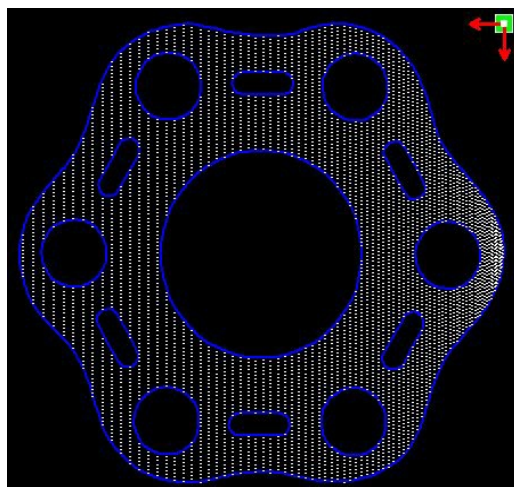
Rectangle method



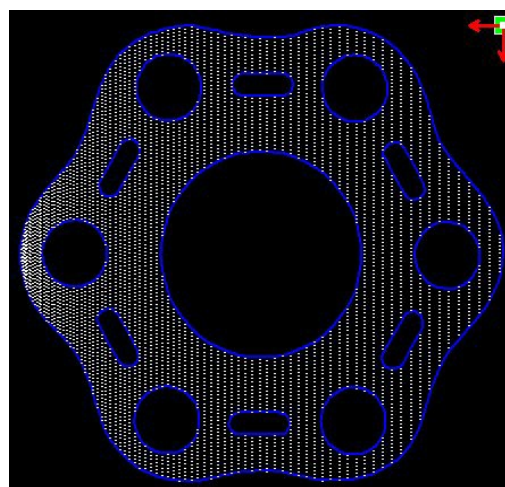
Horizontal line



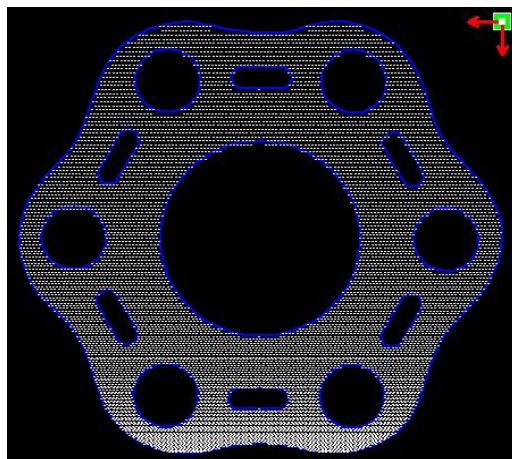
Vertical line



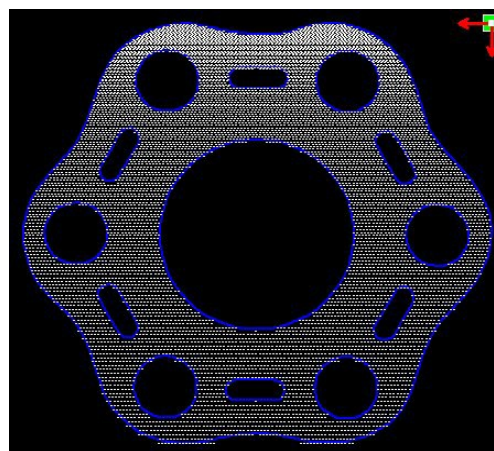
Left light source



Right light Source



Top Light source



Bottom light source

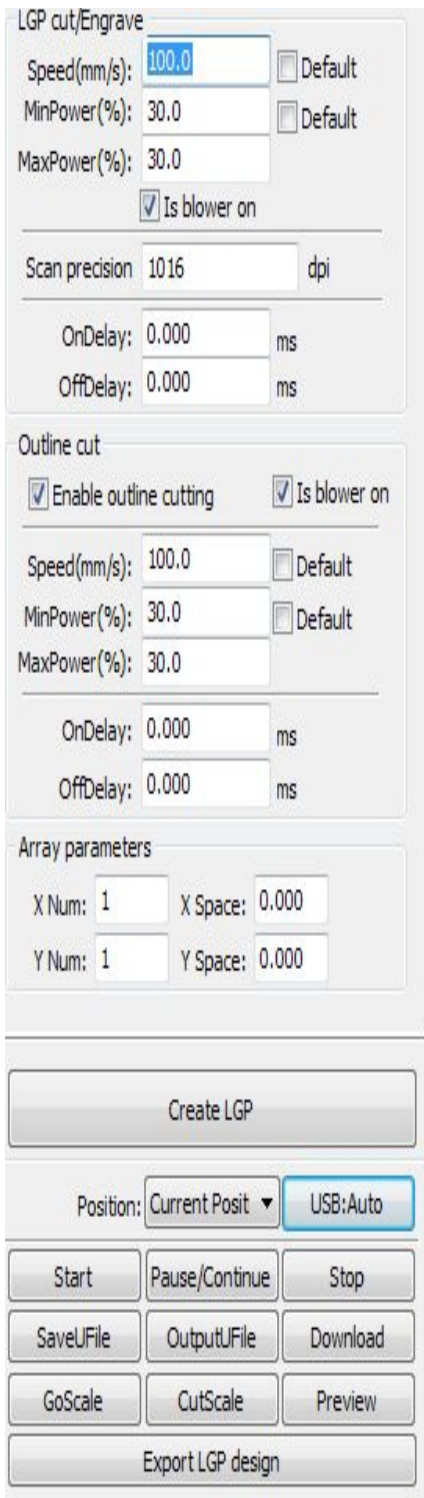


Figure 54

Horizontal, Vertical Line, Reticle, Elliptical.

Rectangular setting is the network scanning mode of output.

Scanning mode, the minimum energy, maximum energy generally is the same, and default the delay is 0. By adjusting the scanning system precision, to adjust the scanning density for higher accuracy the finer the scanning line is. Scanning with lower accuracy, the scan lines are more sparse.

The grid processing methods of cutting, and scanning is not precise and can be adjusted according to the actual effect, the maximum and minimum energy light type of delay, generally speaking, the least energy gives a slightly lower effect than the maximum energy.

If you need to cut the reflex outline, you can make a contour cut. Cutting parameters and the common cutting Settings in here are identical.

If you need to process the array as in processing more panels, the array parameters can be set. The array direction along the machine is always the origin in the opposite direction.

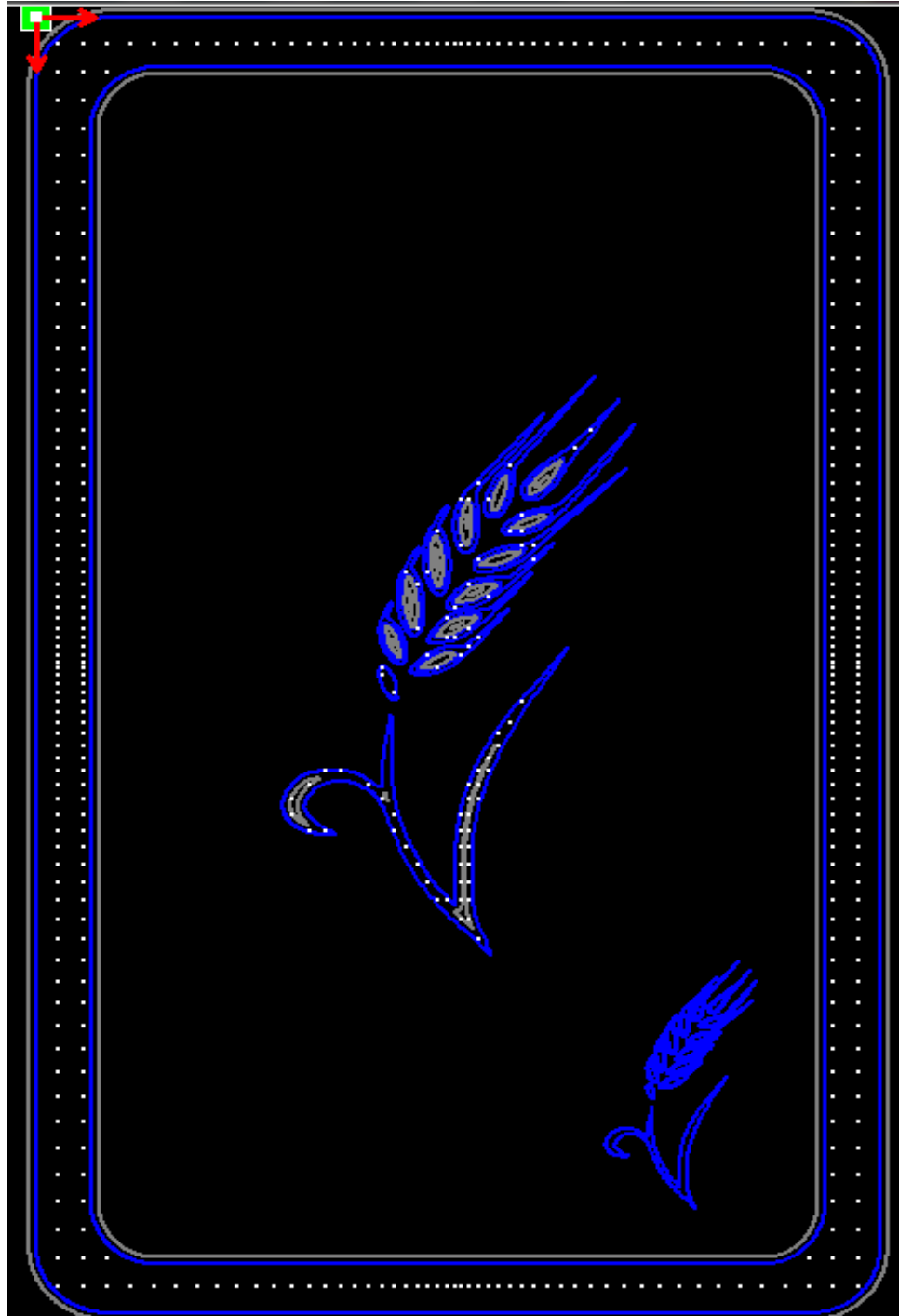


Figure 55 An example of LGP design.



An excerpt from a post in the RDWorksLab.com forum by Dropcat  
<http://rdworkslab.com/viewtopic.php?f=3&t=227>

Took me a while to find the Import option under the System tab.  
I saved my name as a file, imported that, and it put the dots inside each letter. Neat.

I also noticed under the System tab I can select Rectangle or Ellipse to set the shape.  
OK, I got this sussed out. The UI is terrible, but the concept is simple once you wrap your brain around it. One problem is it doesn't disable some entries when it should, and you get confused when fiddling with those and it does nothing.

The theory is, you want a few big widely spaced dots near the light source, and lots of tiny closely spaced dots far away from the light source.

To keep it simple leave it set to the default, so a 200 x 200 mm box.  
For 'Light source' leave only Top ticked, so this is an edge-lit sign you'd hang from the ceiling with the light at the top.

Define the LGP type as ellipse, and set its size using the Width & Height boxes. Of course to get a circle set them the same, so 1mm.

For now set the UpGrad & DownGrad to 0mm, and under Space set Up, Down, Left, & right to 5mm and the Grad values to 0mm

Under 'Dislocation' (Offset) un-tick both row & column.

Click 'Create LGP' and you get an evenly spaced grid of dots, all the same size.

Dislocation alternates the grid spacing, tick either row & column and then 'Create LGP' to see the effect. Turn both off for the moment.

Grad is short for **gradation**, the idea is to set the SMALLEST dot size & row spacing, and then set how it should increase.

**Read the above again!**

Below Height & Width you have UpGrad, DownGrad etc. This sets how the size of the dots change depending on how far from the light. Now this is kinda backwards, since we are starting from the smallest dot (away from the light at the top) you want to set UpGrad.

This is the dot size increase for each row. The first UpGrad value increases the dot width, the second the height. Make them both the same, say 0.1mm to keep them as circles. So the first row of dots will be 1mm, the next 1.1mm, then 1.2mm and so on.

Set both to 0.1mm and update. You'll have small dots at the bottom, big at the top.

(Remember the light is at the top.)

Setting the DownGrad numbers does nothing, they should be disabled like Left & Right are.

(If the light was at the bottom then everything said above would be reversed, and the same for Left & Right.)

Row spacing follows the same idea; you have a default start spacing, and then the step size. (Again Down does nothing, only set the Up values). Leave Up as 5mm, and set the Grad to 1mm. From the bottom the first row spacing will be 5mm, then 6mm and so on.

Notice you can set Left & Right, this sets the spacing of the columns. You should probably make those the same as the Up spacing. You can't set the Grad which is fine as the light source is at the Top.

The dot Grad needs to be smaller than the Space Grad, otherwise you'd lose the gaps between the dots.

For a square if you ticked both Top and Bottom light sources, the row would start in the middle and head towards the edges. Size & Row figures should be set identically.

For a circle pattern you'd tick all four light sources, and set all the spacing & graduation figures to be the same for an even pattern. In that case the smallest dot would be in the middle, and everything would work outwards.

I'm not sure what good numbers would be, maybe someone can measure one of those LED lights as per the video. You'd be using numbers in the 0.1mm size & 0.001 grad range I guess.

Interestingly there are some minimum sizes, like the shape size can't be below 0.1mm and spacing below 0.5mm.

**The best way to learn how to use this really fun function is to play with it.**

### Chapter 3 System Settings

Before graphics can be output, it is important to ensure that the system settings are correct. To do so, Click on menu **[Config(S)]** -> **[System Setting]** to invoke the dialogue box.

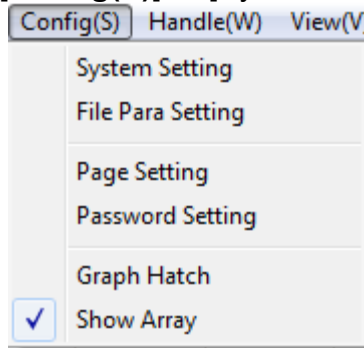


Figure 56

#### 3.1 General Settings

Click on menu **[Config(S)]** -> **[System Setting]** to invoke this dialogue box.

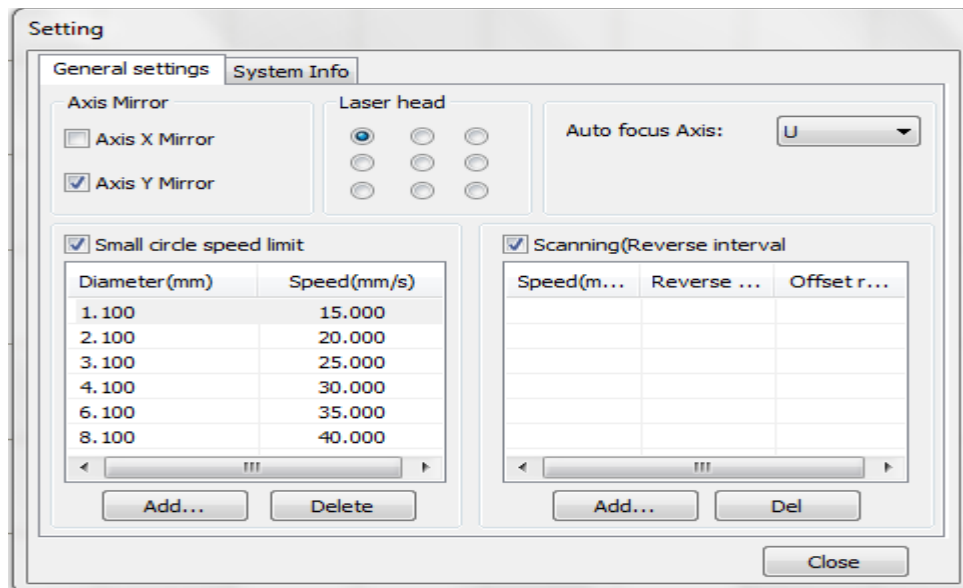


Figure 57

#### Axis Mirror:

Generally, the Axis direction of the mirror is based on the actual location of the limit switches or the home location of the machine. RDWorks uses Cartesian coordinates, also known as X-Y coordinates, by default.

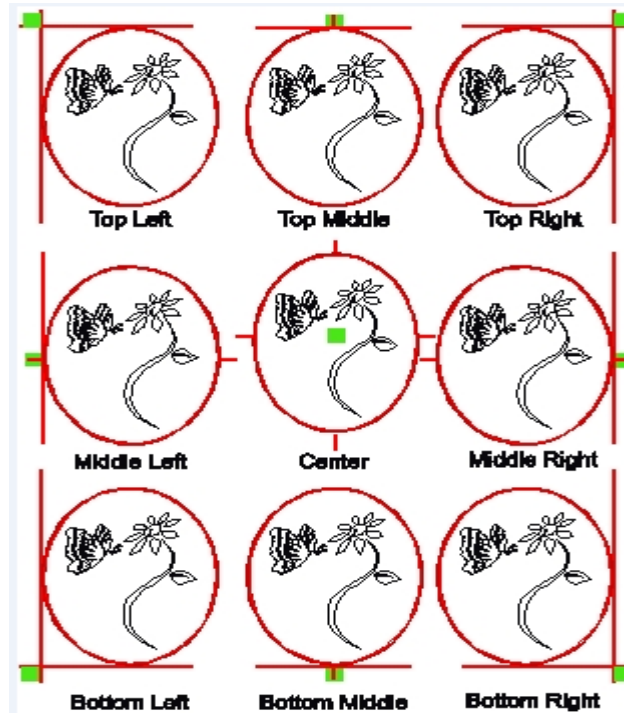
If the home point of the machine is set to the top left, then the X-Axis does not need mirroring. Although you do not need to mirror the X-Axis you still need to mirror the Y-Axis.

If the home point of the machine is top right, then both X-Axis and Y-Axis need to be mirrored. If your graphic or text is reversed or flipped, you have not set the mirroring correctly.

Frequently, it is just the Y-Axis that needs to be mirrored. If the LCD displays reversed, see <http://rdworkslab.com/viewtopic.php?f=39&t=483> or view **Section 1.08**.

**Laser head:**

Position of Laser head means the location of the laser head relative to the graphic.

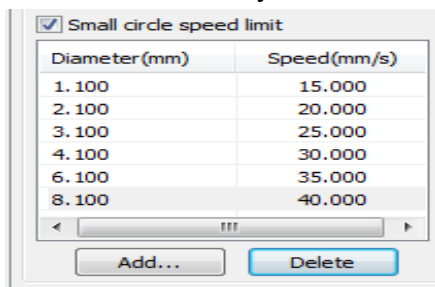


**Figure 58**

This green determines how the program is written. If you have selected SCAN mode for any parts of your program, the top 3 dots will cause the scan to progress DOWN the image. Selecting the start point in any of the other 6 positions will create a program that scans from the BOTTOM upwards.

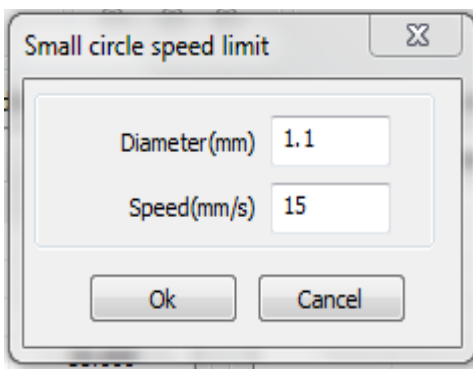
**Small Circle Speed Limit:**

Cutting, or engraving, small circles may be difficult for your machine. Moving the weight of the laser head around the diameter of a small circle can cause faults. If the speed of the laser head is limited to counteract any momentum issues the accuracy of small circles may be increased.

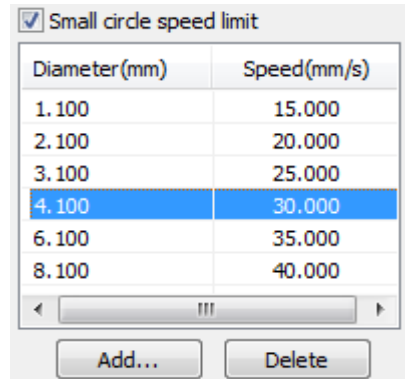


**Figure 59**

Note: the settings in the example from top to bottom are 1.1 mm then 2.1 mm ... not #1, #2 ... Click the Small circle speed limit check-box, then click on **[Add]** to add a setting.



**Figure 60**



**Figure 61**

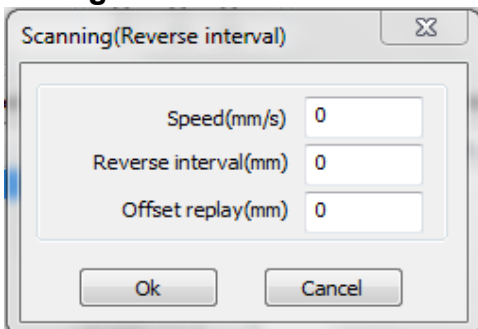
To delete a setting, Select a line and then click on **[Delete]**.

**Scan backlash:**

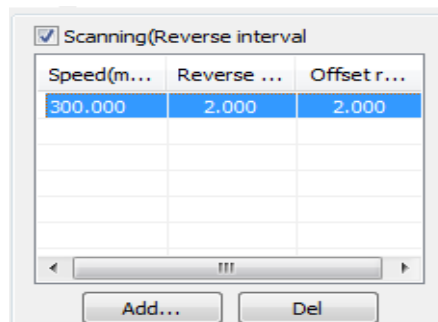
Backlash is caused by the inclusion of a small amount of clearance, or play, needed to allow the cogs and drive belts to move without putting too much force on any component. Rubber belts have an inherent amount of give, they just like to stretch and when the laser head reverses its direction the play in the system means there is a tiny difference in where the software thinks the laser head is and where it actually is. The amount of backlash will, generally, increase as the cutting or engraving speed increases.

When engraving graphics, this difference, as small as it may be, may result in the edge of a graphic becoming uneven. To reduce this we add compensation.

**Adding Backlash:**



**Figure 62**

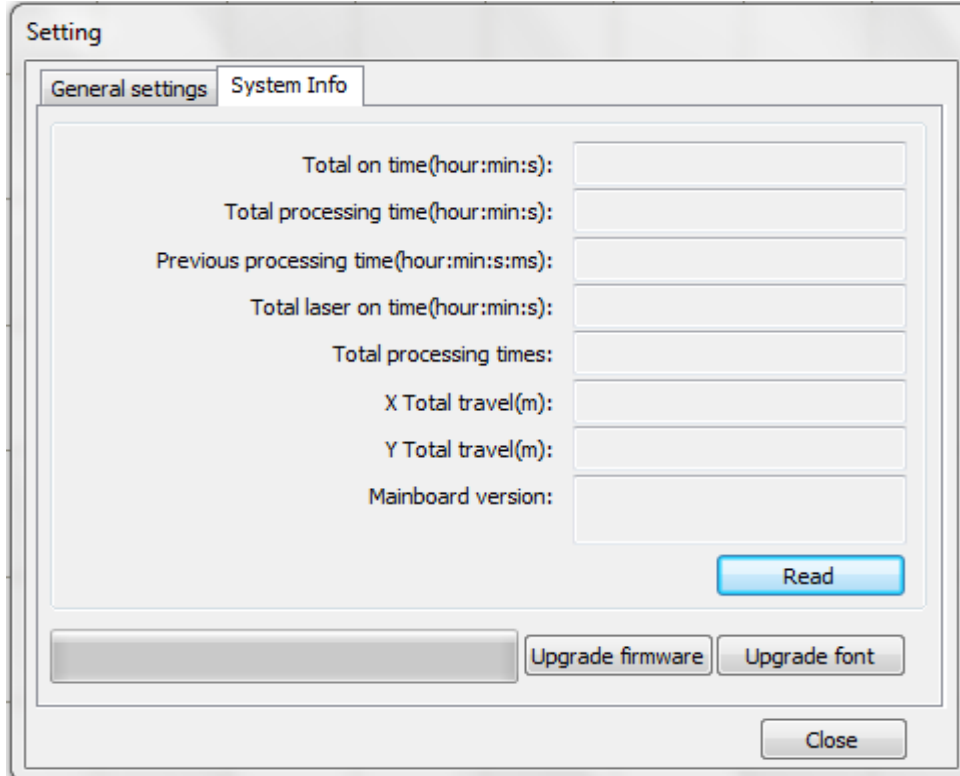


**Figure 63**

To change the reverse interval scanning dialogue box (in **Figure 62**), the user should first click on the “Scanning(Reverse Interval)” check-box (in **Figure 63**), then click on the **[Add]** button, and set the distance and speed needed to modify the reverse block entry clearance. Set speed and backlash and click **OK** in the dialogue box and the backlash compensation will be applied. To delete a setting, highlight the setting and click on the **[Del]** button.

To obtain information on the controller and its parameters, the correct password “RD8888” must be entered in the dialogue box shown above.

### 3.2 System Information



**Figure 64**

You will need to have your computer hooked up to the laser, then click on the "Read" button. This will read the data from your laser.

Four of the more important pieces of data related to time are as follows;

**Total on time** refers to the total time the controller has been working.

**Total processing time** refers to the total time devoted to processing, including rapids.

**Previous processing time** is the total time of processing, the last time the program was run.

**Total laser on time** refers to the total time the laser has been fired.

The **X Total travel (m)** and **Y Total travel time (m)** are total travel of motors X and Y, respectively, in minutes.

**Mainboard version** is simply the version of the software installed in the controller.

If an upgrade for the controller exists, it will be in the form of a \*. bin file. After the upgrade, the user must click the "Reset" button on the control panel before the controller can be used normally.

### 3.3 User parameters

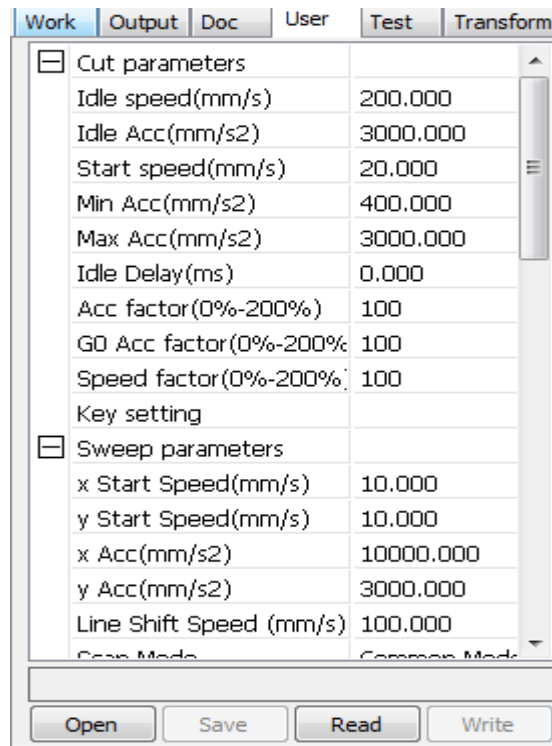


Figure 65

One must “Read” the board parameters from the Laser before setting the user parameters. To do this, Click on “**Read**” with the USB cable attached to your laser, and with the laser turned on. If you do not see the buttons as shown, slide the “Laser Work” panel a bit lower.

It is highly recommended that you save this file the first time you have “Read” it. The Save button will be enabled once you have read the machine settings. **See Section 1.06 for the reason to save your original settings.**

#### 3.3.01 Cut parameters

The Cut parameters (shown in **Figure 65**) include provision for setting the following parameters:

**Idle speed:** This parameter determines the maximum speed of all laser head movements when the laser is not firing during the operation of the machine. This parameter should not be lower than the lower of the start speed of the X-axis or the Y-axis, and it should not exceed the higher of the maximum speed of the X-axis and the Y-axis. If a setting is set too high, the controller will automatically reset the illegal parameter to a value within the permitted range. Although slightly higher idling speeds shorten operation time, **excessively high idling speeds can cause a vibration of the tracks**; therefore, you should consider this, along with the additional wear and tear to the machine that a very high idle speed causes and take care not to set it too high.

**Idle Acc:** (acceleration) refers to the acceleration speed of the laser head and point to point speed of acceleration while not firing. If the idle acceleration is set too slow, the actual speed may not reach the value set for motion; if it is set too fast, the unit may not be able to absorb the resultant mechanical vibration, producing jitter. Idle acceleration generally should be set slightly higher than of Max Acc (acceleration) .

**Start Speed:** Corresponds to the acceleration up to the speed of cutting. This cutting speed is the speed set in the layers "Cutting Speed" parameters of the selected layer.

**Min Acc:** The least amount of acceleration when not lasing.

**Max Acc:** The maximum speed that the laser can accelerate. If set too high, it can cause the stepper motors to loose steps. This is heard as a humming like sound with the head not moving when it should be.

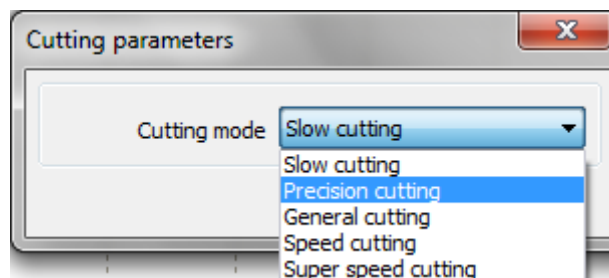
**Idle Delay:** The amount of delay from the time the machine goes from rest to moving.

**Acc Factor:** The amount of global speed setting, as a percentage, to apply to the other settings. To lower by a percentage, set to something like 80% to increase set to 120% or your desired amount of decrease or increase.

**Go Acc factor:** The "Go Acceleration factor " is related to boundary cutting speed. The greater the ratio, the greater the cutting speed.

**Speed factor:** The speed of turning around corners will increase as this parameter increases.

**Key Setting:**



**Figure 66**

This sets the primary mode of cutting. There are 5 choices; Slow cutting, Precision cutting, General cutting, Speed (Fast) cutting and Super speed cutting (Very Fast). Select your primary cutting mode and click on "OK" to save or "Cancel" to exit without changes. This will change the speed settings of your "Cut parameters".



### 3.3.02 Sweep parameters (Scan)

The input screen (shown in **Figure 67**) sets sweep parameters. The definitions of the parameters in the input screen below are as follows:

<input type="checkbox"/>	Sweep parameters	
x	Start Speed(mm/s)	10.000
y	Start Speed(mm/s)	10.000
x	Acc(mm/s <sup>2</sup> )	10000.000
y	Acc(mm/s <sup>2</sup> )	3000.000
	Line Shift Speed (mm/s)	100.000
	Scan Mode	Common Mode
	Facula Size(50~99%)	80.000
	Engraving factor	100

**Figure 67**

**x Start Speed and y Start Speed:** Used along with the stepper motor drag, the use of x or y start speeds allows work to start directly from a non-zero speed to shorten overall processing time. The X and Y axial load is different from each other, the initial speed of the X-Axis should be slightly higher than the initial speed of the Y-Axis.

**x Acc, y Acc:** The x and y Acc. (acceleration) parameters must be set to match the scanning speed (the speed of processing as set in the Layer Parameters). If the x and y Acc. parameters are too small, scanning efficiency is negatively affected. The machine can be set to the actual inertia load as X and Y Axis loads are much higher than the X-Axis or Y-Axis acceleration loads.

**Line shift speed of scanning:** This parameter is used to control the maximum speed at which scanning shifts from one line to the next line. This function is used when precise line and/or block positioning is required and the line space or the block space is too large. The user can set the line shift speed of scanning to a comparatively low value. This parameter cannot be less than the jump-off speed of the corresponding axis during the line shift, nor can it be higher than the maximum speed of the corresponding axis during the line shift. If the setting is illegal, the controller will set this parameter within the allowed range.

**Scan mode:** Two scanning modes are available, Common Mode and Special Mode. The Common Mode does not allow treatment during the scan, while the Special Mode allows the treatment of light spots. If the Special Mode is activated, the power of the laser will be increased in such a way as to reduce the proportions of light spots. Laser power attenuation will be higher, to achieve the same depth of scanning. The purpose of selecting the Special Mode is to make the laser fire high power short duration beams. During deep scanning, such beams have the effect of achieving a flat bottom effect. If, however, the light spots are improperly adjusted, this effect may not be achieved. Using the laser in high power for even a short duration can reduce the service life of the laser. The Common Mode is the default.

**Facula Size: (Laser Dot Size)** When scanning using the Special Mode, this parameter is used. The dot size can be controlled by 50% to 99%.

**Engraving Factor:** Controls the speed of engraving, by an entered percentage, on a Scan layer.

### 3.3.03 Home parameters

<input type="checkbox"/> Home parameters	
Home speed(mm/s)	20.000
Auto home X	Yes
Auto home Y	Yes
Auto home z	No
Auto home U	No

**Figure 68**

**Home speed:** This parameter determines how fast the laser head is moved back to the origin. On a larger format machine, the speed can be increased slightly. It is machine dependent as it increases stresses on the axis drivetrain.

**X, Y, Z, U & Auto home:** These axis can be set as to whether they should be reset at boot time. The “Home offset” from “0” is in the Vendor settings.

### 3.3.04 Feeding parameters: - Requires a Feed Source, like a belt table

<input type="checkbox"/> Feeding parameters	
Delay before feed(s)	0.000
Delay after feed(ms)	0
Progressive feeding	No
Progressive feeding repa	0.000
Last feeding	Yes

**Figure 69**

**Delay before feed:** This parameter refers to a pause before material is fed. When it is used in combination with the feeding device, the user can allow for such hands-on operations as sorting material by setting the delay (in seconds) before feeding to some appropriate value.

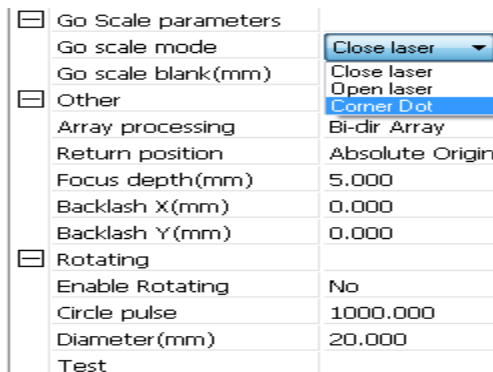
**Delay after feed:** This setting makes the feeding device pause for a specified duration after it has moved the material to a designated position. It is invoked whenever a brief period of stability is needed before final processing.

**Progressive feed repay (replay) :** This feature is used when there is some error in the rate at which the feeding device moves material line by line.

**Progressive feed:** A way of feeding the material sent in place of one line.

**Last Feeding:** Should the last operation be a feeding operation to move the material out of the way? Yes/No.

### 3.3.05 Go Scale parameters



**Close laser will not fire the laser**  
**Open laser will fire the laser**  
**Corner Dot does not seem to do anything**

**Figure 70**

These settings are used in conjunction with border-related functions while processing on or near the border with independent software. The meanings of the parameters in it are:

**Go scale mode:** Laser will fire around the border, for opening cut borders and three corner modes, Close, Open, Corner & Dot.

**Go scale blank:** The moving frame is based on the actual image around all sides. This setting adds a space, as entered, to the side of the border in order to ensure the frame completely contains the actual graphics.

### 3.3.06 Other parameters

**Array processing:** There are two options for Graphic (array) processing, Bi-dir (Bi-Directional) and S-dir (Single Directional).

**Bi-Directional Array mode:** cuts the Graphic array back and forth in order;

**Single-Directional Array mode:** always cutting the Graphic array from one direction to another. If Single-Directional mode is selected, all units have the same movement modes and the same liquidity of movement, however, this mode will take more time than the Bi-Directional Array mode. The default mode is the Bi-Directional Array mode.

**Return position:** You can select the locating point and the machine origin. This parameter decides the position, the locating point or the machine origin, where the laser head stops upon completion of each operation. Choices are Origin, Absolute Origin and Not (no) Return.

**Focus depth:** Auto focus operation to find the correct focus on the material. This setting depends on the focal depth of the installed lens.

**Backlash X, Y:** Used to compensate backlash caused by machine drive belt problems.

### 3.3.07 Rotating parameters

Work	Output	Doc	User	Test	Transform
	Go scale mode			Close laser	
	Go scale blank(mm)			0.000	
<input type="checkbox"/>	Other				
	Array processing			Bi-dir Array	
	Return position			Drawn Origin	
	Focus depth(mm)			5.000	
	Backlash X(mm)			0.000	
	Backlash Y(mm)			0.000	
<input type="checkbox"/>	Rotating				
	Enable Rotating			No	
	Circle pulse			1000.000	
	Diameter(mm)			20.000	
	Test				
<input type="checkbox"/>	Wireless panel				

**Figure 71**

**You MUST use the “USER” setting tab to enable Rotary Engraving. Rotary engraving is only used when the Rotary Axis replaces the Y-Axis.**

The rotary, either the roller or chuck type, plug in and work the same way. The Y-Axis is replaced with the Rotary Axis.

**\*MAKE SURE THE MACHINE IS TURNED OFF BEFORE PROCEEDING\***

**Hardware Rotary Setup** Remove the Y-Axis connector. Then plug in the rotary's 4-pin female connector in place of the Y-Axis connector. The location will vary by machine model. Some connectors are even inside by the controller.

**Important!** If the image looks mirrored vertically/horizontally, move the motor side of the rotary to the opposite side of the table by rotating the rotary 180 degrees. Now turn the machine on and let the laser head return to the home position. Since you unplugged the Y-Axis connector and replaced it with the Rotary attachment, you'll notice that the laser head will only go to the left (or right depending on your heads home position) until it hits the X-Axis limit switch. This is normal and what it should be doing. After the laser head has moved all the way to the to the normal X-Axis home position, and stopped, move & push the gantry all the way to the back of the machine so that the Y-Axis limit switch has been triggered. Doing so, the rotary is correctly adjusted with the corresponding coordinates of your worktable and now should be ready to be used. You can now move the head to position it over the item to be engraved on the rotary. Before continuing to the software portion of the setup, make sure the USB cable is connected between the laser and the PC & that the laser is turned on.

### **3.03.07.01 Software Chuck Rotary Setup**

Open RDWorks (if you haven't already) and located the User tab on the right side of the software. Click on the **Read** button below and if the machine and PC are connected correctly, a 100% status bar should appear. **Figure 71** shows where to enable the rotary and input your circle pulse. The circle pulse is the number of pulses it takes to turn the Chuck a full 360 degrees. NOTE: The Circle Pulse does NOT work with all versions of Controller software. Quick test is to move your y axis to the home position and draw a line 50 mm long in the y axis. Click on Read in the User Settings, enable Rotary. Set your "Circle Pulse" to 5000. Write this setting and do a frame. Note where the y axis moves to. Then change the Circle Pulse to 10000, Write, then do the test again. If the y axis moves to a different spot, then the Circle Pulse WILL work on your machine. If not, you will have to do it using method #2, described after the Circle Pulse Method.

For a test, the "Circle pulse" can be one of these common numbers. They are 400, 800, 1000, 1600, 2000, 3200, 4000, 5000, 6400, 8000, 10000, 12800, 20000, 25000 and 25600. If you know what the stepper controller for your Y-axis is set to, that is the number to use. Most drivers will have switch settings printed on the face of the case. Then one must multiply by the gear ratio. One must take into account the gearing that is specific for your chuck. Count the number of teeth on both pulleys. Divide the Chuck Pulley (A) Number by the Stepper Pulley (B) Number. Then multiply the the Controller Stepper rate by the pulley result. **Example:** Stepper pulley has 24 teeth, Chuck pulley has 48 teeth and the Controller has a rate of 8000. The result would be  $(48/24 = 2) * 8000 = 16000$ . In this case, the number (16000) is the number to put into the "Circle Pulse" setting.

To test this, draw a box with a Y dimension the same size as your chuck circumference. Place masking tape on the chuck when it is at a zero position. Then do a frame or a Test. It should rotate to that mark. If it goes past the mark, the numbers are too low. If it doesn't make it to the mark, the numbers are too high.

To setup the Chuck Rotary, the **Diameter (mm)** will be the only variable that will be changed depending on the diameter of your material. Now measure the diameter of your material and input that number, in millimeters, in the Diameter box as shown in **Figure 71**.

For all machines using this method, the **circle pulse** will always be set to the number that you have determined to be correct and once figured out, **it should never be changed when using the Chuck rotary**. Only the **Diameter (mm)** should be changed. Input the correct diameter of the object to be engraved, then click on the **Write** button. ***This must be done every time you change any values in the User Tab.*** Again, before running your job using the **Chuck** rotary, make sure that the curvature of the material is leveled on the **Chuck** rotary and that the autofocus is aligned at the peak (top-most surface) of your material. Just be very cautious when using the **Frame** (test box) when using the Chuck rotary so that the laser head and/or the autofocus pen will not ram into the material or the motor of the rotary.

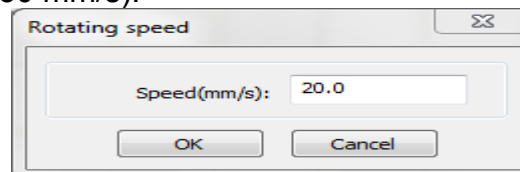
**Method #2:** This is another method of adjusting for the Chuck style Rotary. Determine the length of a vertical line that will drive the rotary 360 degrees.

This will take some experimentation. One might start with a number of 50 mm and work either higher or lower until there is a full 360 degree rotation of the chuck. Lets say for an example that the number turns out to be 48 mm. Calculate a **vertical scale factor** as  $100 \times 48 / (\pi \times D)$  where  $\pi$  is **3.1415926535** and **D** is the diameter of the work piece. This would then be:  
 $100 \times 48 = 4800 / 3.1415926535 = 1527.88745$  which we will round to **1527.89 / D**

For each work piece diameter, calculate the scale factor as  $1527.89 / D$  for your machine. Once the graphic is in RDWorks, make sure the aspect ratio lock is **off** and then scale the Y-dimension by the calculated percentage. If for example the work piece **Diameter** was 40 mm the scaled result for the Y axis would be  $1527.89 / 40 = 38.197$ , so you would scale the Y axis by 38.197%. Then, send the job to the machine.

### Adjusting Frame/Test Speed:

**\*The following method works for both Chuck & Roller Rotaries\*** For best practice, **always** frame on your image (by pressing the **FRAME** button on your LED Control Panel or by using the "Test" button in the user panel) on the material by making sure the image is going to engrave/cut correctly whether on the roller or chuck rotary. The default testing speed when framing is 50 mm/s. For the roller rotary, this will be problematic because at this speed, your material will more than likely "fly off" your roller rotary, so you will need to reduce this speed (recommendation: 5-30 mm/s).



**Figure 72**

If adjusting for the "Chuck" style rotary, click on the "Test" in **Figure 71** and a dialogue box like **Figure 72** will appear. Set your desired speed. Adjust the speed to where your material will not fall off the rotary, press "OK" and the rotary will turn to the bottom of the object.

### **3.03.07.02 Small Roller Rotary Setup**

Setting up the small roller rotary is **MUCH LESS complicated:**

#### **Russ Sadler's Method of Rotary Engraving/Cutting – Calculation**

Videos on this process are at:

<https://www.youtube.com/watch?v=wyevrQXaGRo>

<https://www.youtube.com/watch?v=sIIXSZhgbe4>

Russ has a nice method of calculating the numbers for use with rotary engraving/ cutting using the small rollers.

This method involves a large diameter tube. Measure the circumference around the tube (mm works best). Place the tube in the chuck or on the rollers. Now, in RDWorks, draw a line that is the same distance as the circumference. Place Lines at each end, one up and the other down. Set your power to a value for light engraving on paper with a speed of 30 mm/s. Now, rotate the graphic line by 90 degrees.

Save and then Load the designed program in to the machine. Do a frame, then when all is set properly, start engraving. Once completed, **very carefully**, measure the length of the engraved line (actual distance traveled).

Now for some simple math. Take the “Circumference of the tube / Actual distance traveled”. So, if the tube was 150 circumference and the actual distance was 209, we would divide 150 by 209 and get .717703 (x 100) = 71.7703. This is our **Magic Number**. We would now Scale the drawing by 71.7703 in the Y direction once the graphic has been rotated. Do not scale the X axis, although you can if the graphic has not yet been rotated, but then you must rotate the graphic before cutting. Should you desire to return the graphic to the original size we would use the reciprocal 1/X function (of .717703) on our calculator and get 1.3933333 (x 100) = 139.333 and scale the graphic in the Y (or previously scaled) direction.

### 3.3.08 Wireless panel

<input type="checkbox"/> Wireless panel	
Enable speed shift	No
Fast moving(mm/s)	100.000
Slow moving(mm/s)	10.000

**Figure 73**

These settings are used with the wireless control panel, **if installed**. This allows “Wireless” LCD function control. It is an option available from Ruida.

See <http://rdworkslab.com/viewtopic.php?f=17&t=403>

Set to “Yes” to enable speed shifting (allows slow and regular movement speeds) to the settings below it.

### 3.4 Document Management

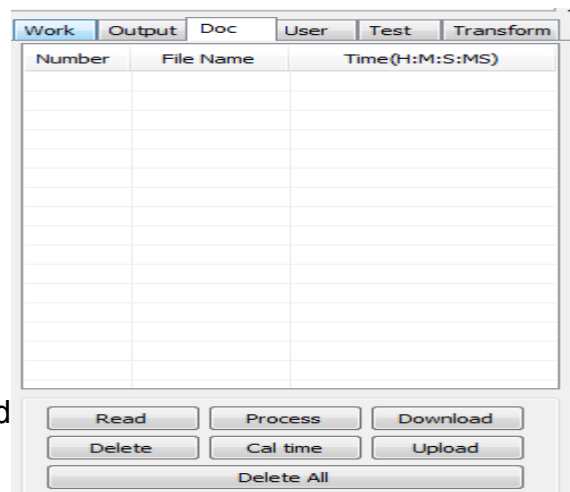
The functions of the features listed in this object are as follows:

#### Read:

The list of files on the controller can be read by clicking the “Read” button. File information will be displayed for the documents in the list.

#### Download:

Clicking on the “Download” button results in download of any number of files in the dialogue box to the controller. All files may be selected by entering the \* wild card for the file name while specifying .rd as the file type. If the download is successful, the document list will update.



**Figure 74**

#### Process:

Select the file to be processed from the document list, and click the Process button. The controller will start the specified document.

#### Delete:

To delete a specific file, select it and click the Delete button. The controller will delete the specified document. If the deletion is successful, the document list will be updated.

#### Delete All:

This button removes all files in the controller and then updates the document list.

#### Cal time:

The controller supports processing files in terms of the time spent applying them in laser operations. The number of hours already spent in applying a particular file can be calculated and displayed by selecting the file and then clicking the “Cal time” button. The user must remember to click the “Read” button to display the results of these calculations.



**Upload:**

The user should click the “**Upload**” button at the bottom right to select offline files and save them to the computer.

### Chapter 4 Processing Output

This chapter describes operation of the Process Control Bar, parts of the System Work Platform, and the Vendor Parameters menu.

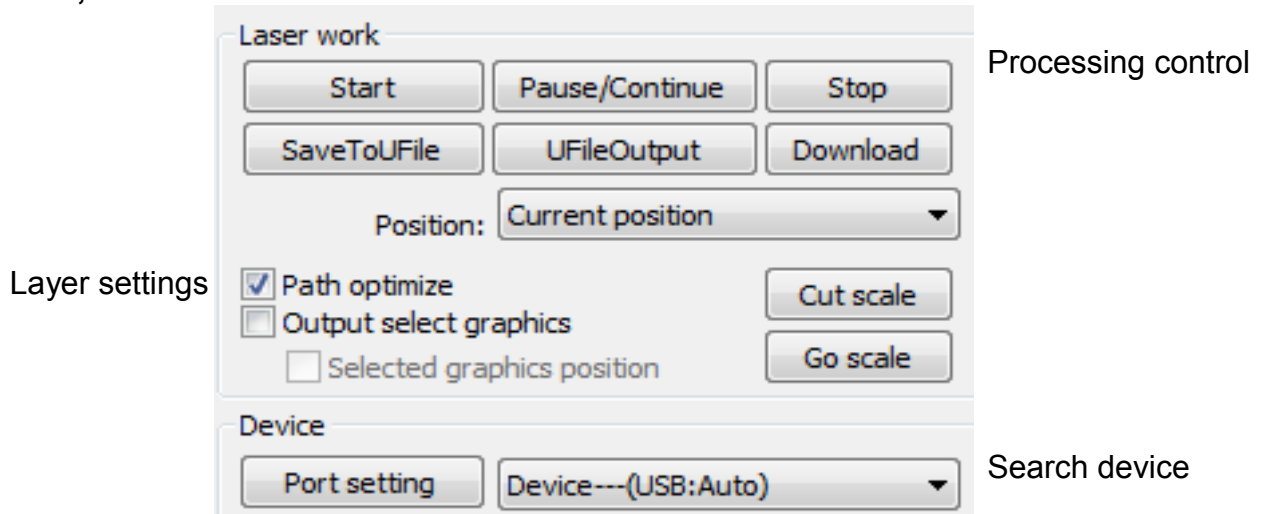


Figure 75

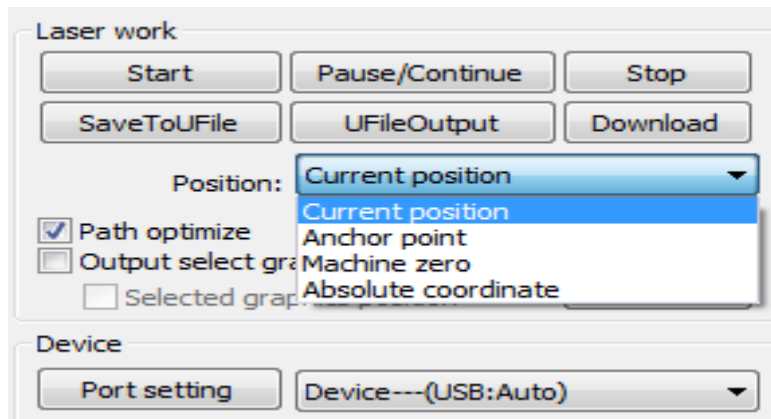


Figure 76

#### 4.1 Search Device

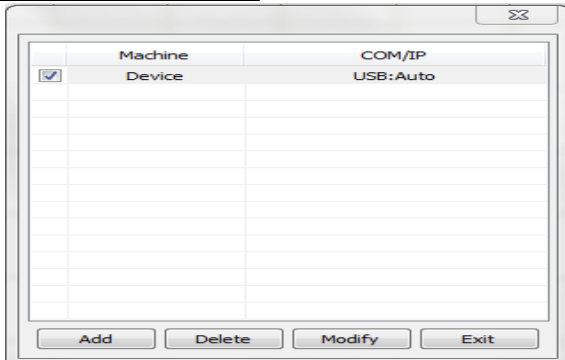


Figure 77

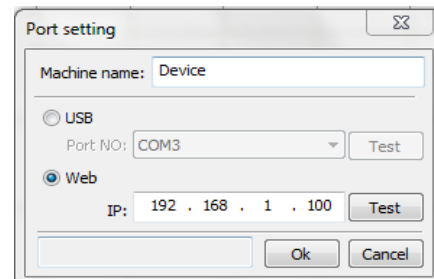


Figure 78

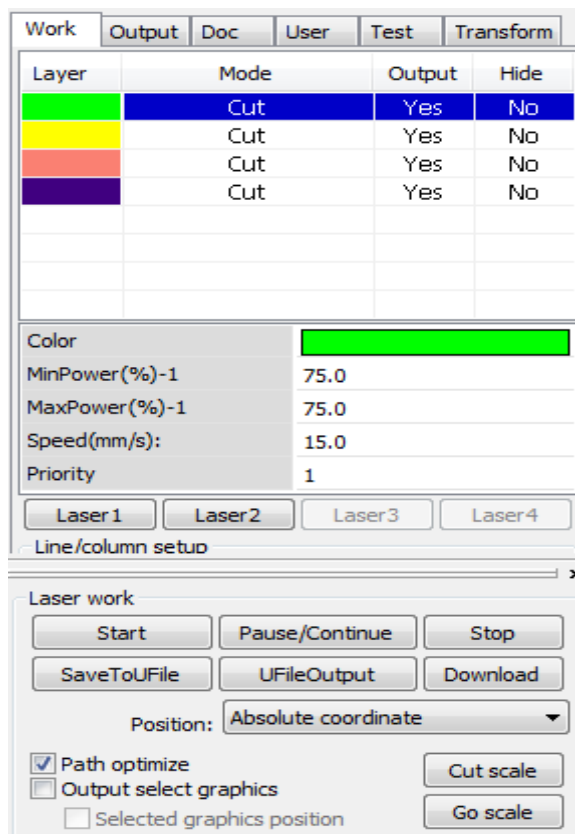
**Device Ports:**

Many of the functions of RDWorks depend on the program communicating with a controller. The computer may be connected to one or more controllers via USB or Ethernet.

The first controller connected via USB can be detected automatically. Any other USB-connected controllers and all Ethernet connected controllers must be added manually.

**To add a controller:** click Port Setting, then Add. Enter the details of the controller to be added in the ensuing dialog. The port can be tested at this point to ensure that the controller is responding properly. If a change is needed controller details can be Modified or Deleted. The controller which is to be communicated with is selected from the drop-down list to the right of the Port Setting button.

**4.2 Layer processing**



**Figure 79**

**Layer reorder:** click on a colored layer and you can change the order of layers by using the mouse to drag the layer up or down to the specified location.

To use these settings, you must check the “Path optimize” option. Note: Regardless of the order you set the layers, scan layers will ALWAYS be processed before cut layers. It is wise to check the cutting order with the preview button before you save your file.

**4.3 Position** the drop-down selects the start point that the laser head will move to before processing begins. The Origin will be set to that point. In all cases after processing completes or is aborted the laser head will return to the point specified in the User parameters.

**Current Position:** starts the job without moving the laser head.

**Anchor Point:** returns the head to the origin before starting the job. Note that any of the other options here will set the origin to the point at which it starts, so this option is only really effective **if none of the others have been used since the user set the origin.**

**Machine Zero:** starts the job from the zero position of the machine.

**Absolute Coordinate:** starts the job at the coordinate of the drawing on the computer.

**Note:** the behaviours are different if the files are retrieved from machine memory at a later time. Only files with Absolute Coordinate will behave as above, all others will start from the Origin defined on the machine at the time.

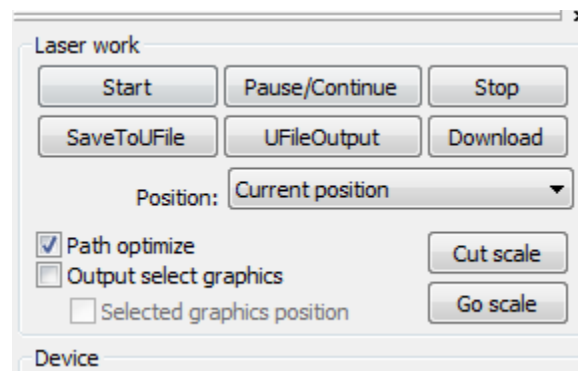


Figure 80

#### 4.4 Go Scale / Cut Scale

**Go Scale:** the button causes the laser head to move in a rectangle around the area of the drawing. A dialog prompts the user to set the speed of movement and the width of blank space around the drawing. Click the “Go Scale” button and the laser head will run along the rectangle (perimeter).

**Cut Scale:** the button does the same but with the laser active, thus cutting the rectangle. The dialog for Cut Scale also prompts for Minimum and Maximum Laser Power to be used. Click the “Cut Scale” button and the laser head will cut along the rectangle (perimeter).

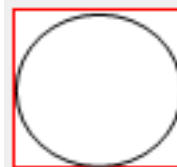
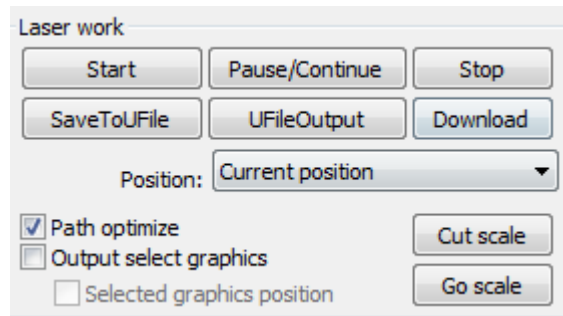


Figure 81

## **4.5 Laser Work - Start/Pause/Stop/Save To UFile/UFile Output/Download**

The functions of these buttons are as follows:



**Figure 82**

**4.5.01 Start** the Start button sends the current drawing to the machine and the machine processes it.

**4.5.02 Pause\Continue** this button pauses the machine operation. Clicking a second time continues from where it was paused. This button is effective even if the job is started from the control panel.

**4.5.03 Stop** this button stops the current process at the machine. The job is aborted. This button is effective even if the job was started from the control panel.

**4.5.04 Save To UFile** the current drawing is saved to disk in RD format. The file may be transferred to the laser machine on a USB stick. A dialog allows the user to assign a name to the file, it is recommended that file names are 8 characters or less since the controller is restricted to 8 character file names.

**4.5.05 UFile Output** an RD file is selected via a dialog box and is transferred to the machine which processes it immediately. After saving a file offline, click Ufile Output to select the RD file for processing.

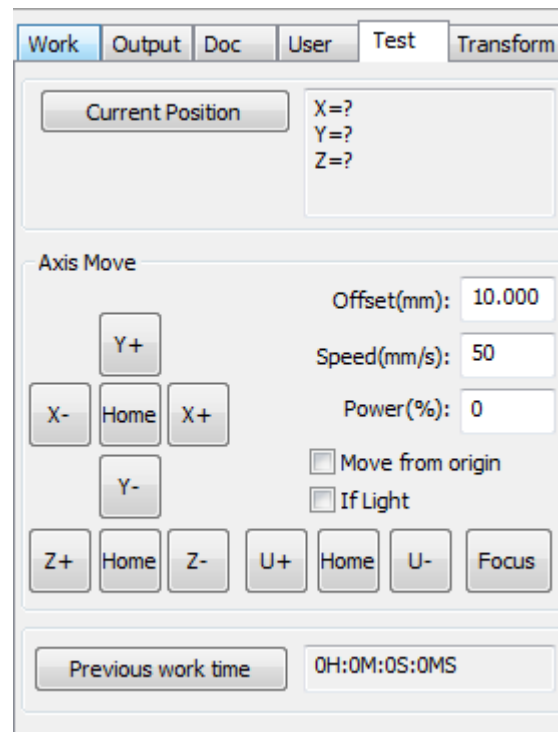
**4.5.06 Download** the current drawing will be transferred to the machine. A dialog lets the user assign an 8 character name to the file on the machine. If the file exists on the machine you will be asked if you wish to overwrite that file.

**4.6 Output select graphics** when the “Output Select Graphics” checkbox is checked, only those parts of the drawing which are selected will be output. If nothing is selected, nothing will be output. If the “Selected Graphics Position” checkbox is checked, the Laser Head Position will be relative to the selected parts of the drawing, if it is not checked the Laser Head Position will be relative to the entire drawing.

### **4.7 Path optimize**

Clicking this button optimizes the path automatically before a file is output. If the file path does not need optimization or has already been optimized, this button should not be clicked because it increases waiting time.

## 4.8 Test



**Figure 83**

In the Test tab of the System Work Platform, the user can read the current position of the Laser Head using the Current Position button.

The laser head can be moved using the X+, Y+, X- and Y- buttons. The Z and U axes, if fitted, can be moved by the appropriate buttons. The Home buttons will return the laser head or axis to the Home position. It should be noted that only one axis can be controlled at a time with the exception of "Home".

The amount and speed of movement are governed by the Offset and Speed input fields.

If the Move From Origin check box is ticked, the endpoint will move to a point relative to the Machine Home position, otherwise it moves relative to the current position. If the "If Light" check box is ticked, the laser will be turned on during the movement at a power selected by the Power input field.

**Move From Origin example:** If Move from origin is checked, and the step distance (Offset ) is 10mm, the head will move to 10mm from machine zero. It's not possible to input negative values in Offset, so it never gets to the controller.

The time taken by the previous job can be read by clicking the Previous Work Time button.

## 4.9 Output Setting

Figure 84

### 4.9.01 RDWorks Rotary Setup

Clicking [Enable rotate engrave] is no longer enabled using this dialogue box. See Section 3.3.07.

### 4.9.04 Feed Setting

To use the feed setting, the feed must first be enabled. After setting parameters for machine feeding, the shaft repeatedly feeds a specified length of material until the specified number of feeding events reaches the total number set. If the machine is not equipped with feeding devices, the “Enable feeding” box should not be checked.

### 4.9.05 Backlash repeat optimization

If the machine’s belt tension causes the edge of the scanned graphic to become uneven, the backlash should be increased. There is a specific relationship between a particular speed and a particular backlash setting but, in general, the greater the speed the greater the backlash setting. Check this box if optimization is desired.

### A note on belt tension from the forum by AbrahamSaenz:

1. Excessive belt tension can cause premature bearing failure increase noise and resonance.
2. Optimal belt tension can actually be used in your favor to help reduce the transmission of stepper motor resonance and noise.
3. Sub optimal belt tension can produce much undesired backlash.

**4.9.06 Laser Head 2 Offset - The Two headed Laser!**

In machines with two laser tubes, any mechanical offset can be compensated for by entering the amount of offset here. This generally is used with two different power laser tubes in a machine because the two laser tube powers can be used for different functions. In some machines equipped with two different powered laser tubes one is responsible for cutting and the other is responsible for engraving.

**4.10 Layer Settings:**

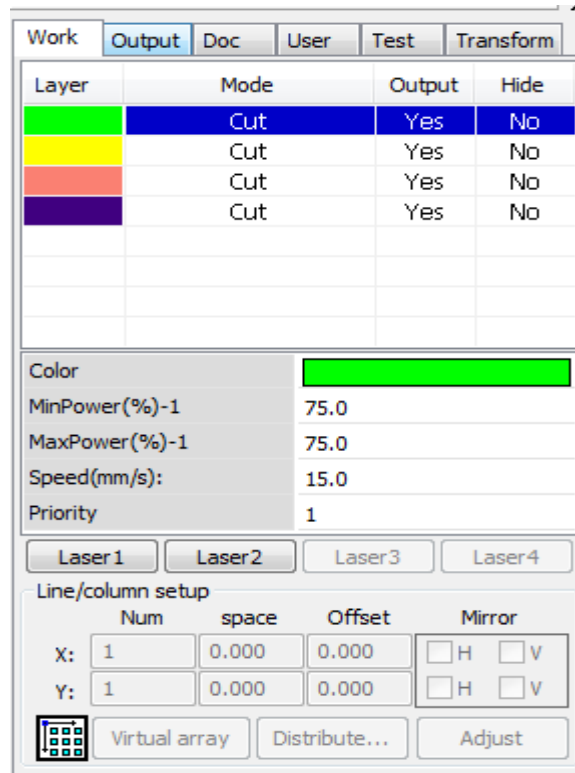


Figure 85

**4.10.01 Position setting**

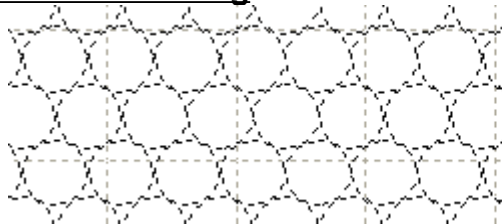


Figure 86

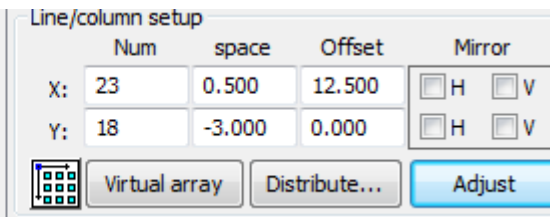


Figure 87



This Icon will change the starting position of the array. Each click will move it to a different corner.

This function, controlled by the input screen shown in **Figure 86** and **Figure 87**, makes it possible to instruct the machine to process a virtual array of a graphic object without the need

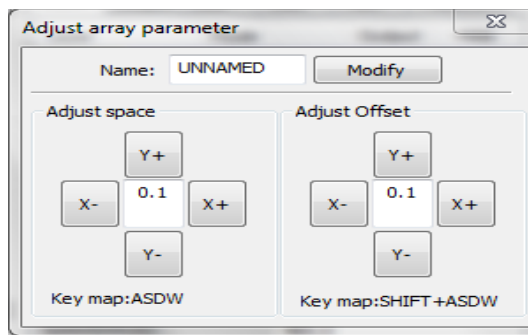


to create actual copies in the graphic workspace. The function is similar to the Object Array Replication command discussed in **Section 2.9.05**. The meanings and functions of the options in the control panel are as follows:

There are two ways to use this function. First it can be used to produce a user specified number of rows and columns of a selected object. Second, it can calculate for the user the number of rows and columns of selected object that will fit within a user specified space.

In the first case, a user enters the desired number of X columns and Y rows of the object, any desired spacing between objects in the rows or columns, and any desired offset (i.e. shifting of alternating rows or columns). The rows and columns may also be alternately mirrored both horizontally and vertically by selecting the mirror check boxes. These settings, combined with rotating the object using one of the rotate commands described previously can be used to efficiently pack the virtual array for maximum yield. Once these settings are made, clicking on Virtual array will display the virtual array layout as it will be processed.

Alternatively, to have RDWorks calculate the number of rows and columns to fit a specific space, select Bestrew (Distribute). This invokes a pop-up in which the user enters the dimension of the space. When OK is clicked, the X and Y numbers are calculated by RDWorks and automatically input into the virtual array settings. The user may further set Space, Offset, and Mirror as described above. The array is then created by selecting Virtual array.



**Figure 88**

By selecting Adjust, the Space and Offset can be adjusted by button clicks that apply the specified adjustment and the result can be observed graphically as the adjustment is made. There are two ways to use this function. First it can be used to produce a user specified number of rows and columns of a selected object. Second, it can calculate for the user the number of rows and columns of selected object that will fit within a user specified space.

In the first case, a user enters the desired number of X columns and Y rows of the object, any desired spacing between objects in the rows or columns, and any desired offset (i.e. shifting of alternating rows or columns). The rows and columns may also be alternately mirrored both horizontally and vertically by selecting the mirror check boxes. These settings, combined with rotating the object using one of the rotate commands described previously can be used to efficiently pack the virtual array for maximum yield. Once these settings are made, clicking on Virtual array will display the virtual array layout as it will be processed.

Alternatively, to have RDWorks calculate the number of rows and columns to fit a specific space, select Bestrew (Distribute) . This invokes a pop-up in which the user enters the dimension of the space. When OK is clicked, the X and Y numbers are calculated by RDWorks and automatically input into the virtual array settings. The user may further set Space, Offset, and Mirror as described above. The array is then created by by selecting Virtual array.

By selecting Adjust, the Space and Offset can be adjusted by button clicks that apply the specified adjustment and the result observed graphically as the adjustment is made.

#### 4.10.02 Setting Laser Cut Parameters

The input panel for setting laser scanning parameters (in **Figure 89**) is brought up by double clicking on the colored layer in the Work tab in the layer settings. Clicking the Parameter Library button brings up the Parameter Library dialog (in **Figure 90**). The parameters of the current layer may be saved with a name and description, and previously saved parameter sets may be selected and loaded into the current layer.

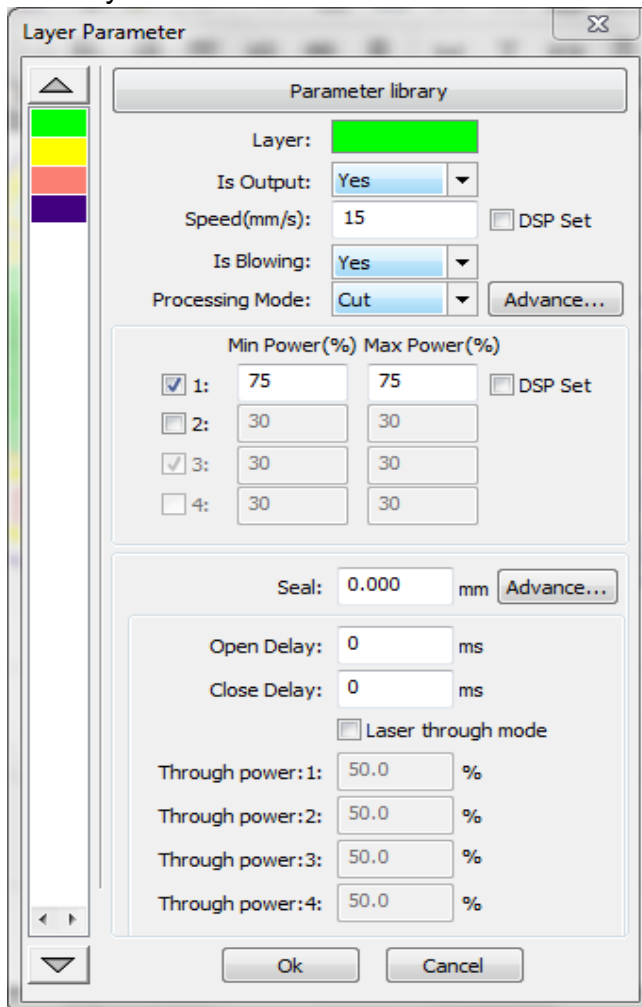


FIGURE 89

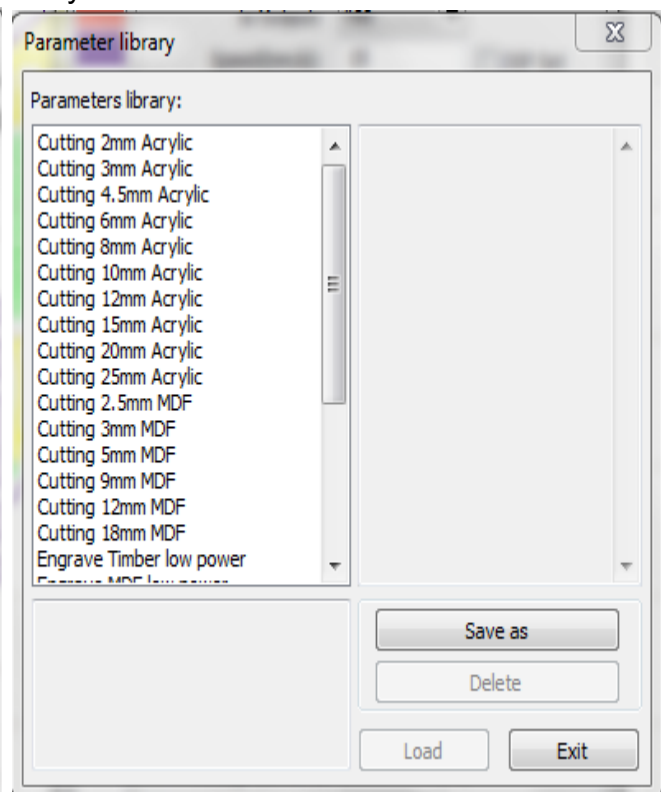


FIGURE 90

To edit something in the layer list, invoke the layer parameter dialogue box (illustrated in **Figure 89 & 90**) by clicking on the layer color. The layer parameters are divided into two parts: public layer parameters and proprietary layer parameters. Public layer parameters are effective regardless of how the layers are processed. Proprietary layer parameters point to the layer of processing type. Change and the corresponding parameters will also be changed. Clicking on group seems to release the virtual array so they can be processed.

**Layer:** Graphic objects may be assigned to differently colored layers. Each layer can have different processing parameters.

**Is Output:** This parameter has two settings, Yes and No. If set to Yes, the corresponding layer will be output. A No setting will result in the layer not being processed. A useful feature of "Is Output" = NO is best described with a simple example:

If you draw a 25mm circle on a black cut or scan layer and then draw a 100mm square around it that is on a blue cut layer, the green datum dot will sit on the top corner of the blue square. If you now make the blue layer "Is Output" = No, the square will not cut but the origin point where the head will start and stop from will remain at the corner of the blue square. This is one of many ways to park the head away from the job after cutting to facilitate easy removal of work

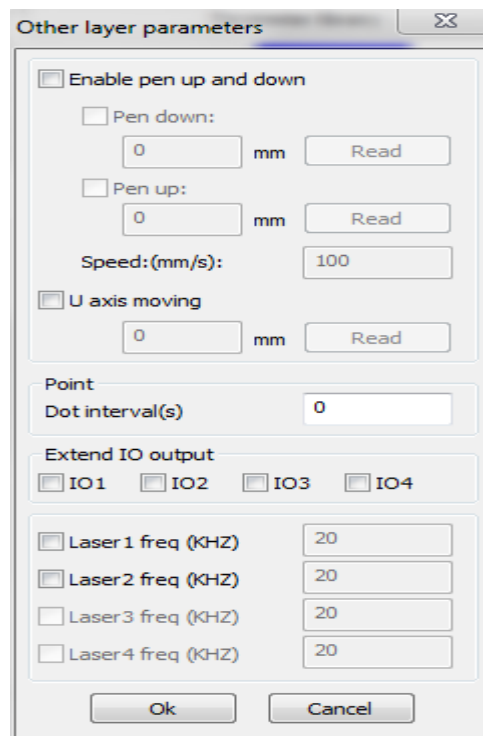
**Speed:** Note that when a smooth cut is paramount, slower processing (and possibly lower power) should be used; faster processing causes the trajectory of the cut to be more erratic. Slower speed will allow deeper cutting for a selected power setting. Faster speed distributes less energy into the cut area. **Note:** If the "Default" LCD box is checked, the speed set on the Control Panel on your machine will be the speed at which the file is run.

Recommended Maximum Scan Speeds will vary depending on your machine mechanics and will vary from 350 mm/s to 900 mm/s and possibly higher. Smoother cuts are created by moving slower. Depending on what you are doing regardless of whether the Mode is set to Scan, Cut, or Dot, speeds may be usefully set from 1mm/s to the machine maximum setting.

**Is Blowing:** This setting controls whether the external air supply is operating. If it is enabled, by selecting it, then this layer setting will allow it to blow on the work. This setting only works if the machine has a solenoid to control air flow. This feature seems illogical because whenever the laser beam is on you MUST always pass air through the nozzle to prevent "fogging" of the lens with fumes/smoke. Therefore there are NO circumstances when you would choose NO. What you do need is a valve to regulate the air assist flow for different materials.

**Processing Mode:** This setting controls how the corresponding layer is processed. If the current layer is a vector layer, it then includes four choices: Scan = Engraving, Cut = Cutting, Dot = Dotting and Pen. If the current layer is a BMP layer (bitmap image), only the Scan mode is available.

Clicking on the **Advance** button will bring up the dialog for, **Other Layer Parameters:**

**Figure 91**

**Min Power-Max Power:** These settings corresponding to the controller laser signals 1 through 4. Note that laser 2 – 4 settings are meaningless if your machine only has one laser tube.

**Minimum power and maximum power:** The power of the values range from 0 to 100, with 100 being maximum laser power and 0 being minimum. When Scanning a Bitmap, the values should be in a range to allow changes in the depth of cut depending on the black levels in the bitmap. **Note:** If the “Default” LCD box is checked, the Min. & Max. power set on the Control Panel on your machine will be the power at which the file is run and will override your programmed values.

The idea of these settings is that they can be set DIFFERENTLY when CUTTING so that at the machine speed changes the power will scale to prevent too much power in the slow sections. That is, if both are set the same during cutting, then in corners, tight curves, and the ends of lines as the machine slows down the material will be over processed. I believe the correct procedure is to run a job with the max and min set the same. Continue testing and adjusting power until the fastest travel speed areas are cut the way you want. Then, if necessary, reduce the min power setting until the slow travel speed areas are cut the way you want.

**Pen up and down:** If the machine includes a lift platform, this function can be enabled to set a different platform height during processing. This function enables the write position to be set to a level such that the auto focus sensor will not interfere with processing of the work piece. If it can be determined that there is no problem with the processing of the work piece, there is

no need to adjust the pen position. This setting may also be used to de-focus the beam to create wood burning or possibly laser origami.

**Seal:** Closed cutting graphics does not require the use of sealing compensation, but un-closed graphics can be closed by means of it. If, however, the sealing is misplaced, there will be no compensation. Enter a distance, in the seal box, that if the un-closed distance is less than, then sealing is desired. Seal defines the overlap of beginning & end of the cut.

**Sew Compensation (Kerf Settings):** A kerf is the width of the cut made by the laser. By default RDWorks cuts along the center of the path. This will result in outside cuts being smaller, and inside cuts being larger. The kerf settings allow you to correct for this. RDWorks calls the Kerf setting “Sew Compensation”. It is found in the cutting parameter window under the Advance button.

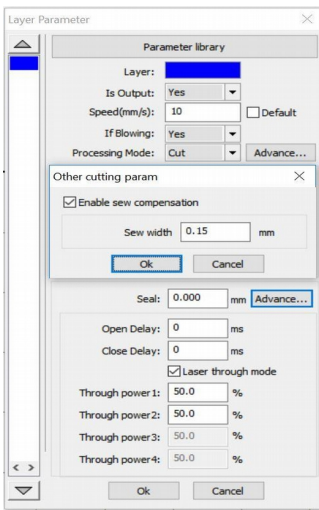


Figure 92

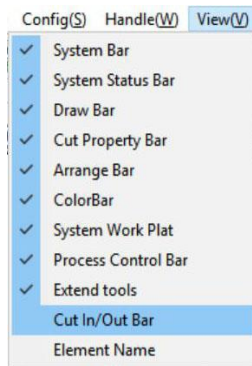


Figure 93

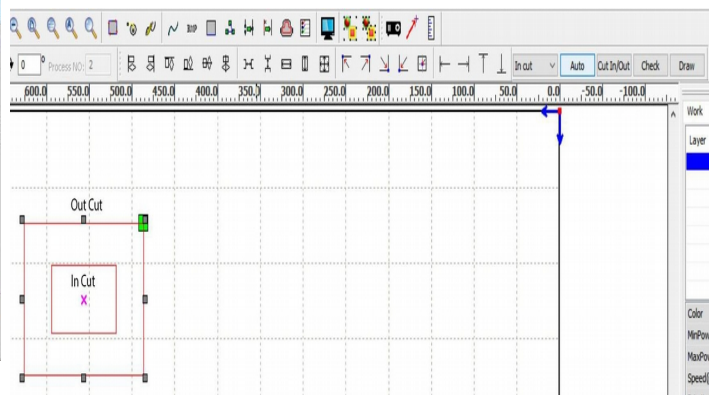


Figure 94

You will need to tell RDWorks if a path is an outside or inside cut. You will also need to have the “Cut In/Out Bar” enabled to set the directions. You can set paths manually or use the auto button. The Auto button works if you select multiple paths. It will set all inner paths as “In Cut” and outer paths as “Out Cut”. To set a path manually, highlight the path and select the offset direction from the drop down menu.

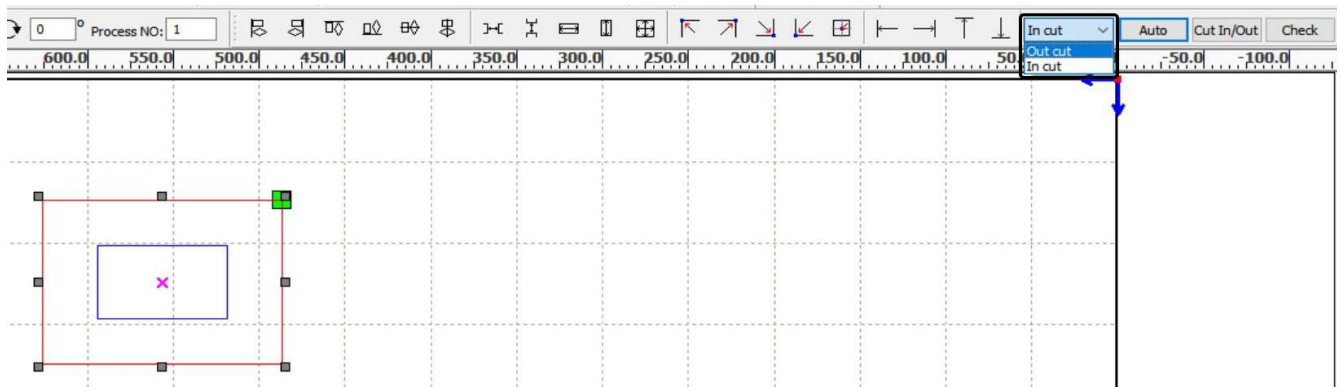


Figure 95

**Open Delay:** Open Delay MUST be used with Laser Through Mode to hold the beam still at the start of EVERY new cut in the program. The power of that cut is defined separately, after which the beam power reverts to the programmed power and the program commences. It's main use is for when more powerful machines are cutting metal, therefore **Through power** will rarely be required for non-metals.

If you do not use Through Power, this **open delay** will still operate and will delay the start of "beam on". Your program will start but the beam will not and you will get an uncut section at the beginning of your program.

**Close Delay:** Close Delay defines a period of time at the end of the cut before the Laser is deactivated.

**Laser through mode:** See Open Delay.

**Through power:** Through power defines the power at which the laser will fire in Through Mode if Laser Through Mode is checked and Open Delay is non-zero.

Other **layer parameters** can be found by clicking on the advance button by the "Processing" mode.

#### 4.10.03 Setting Laser Scan Parameters:

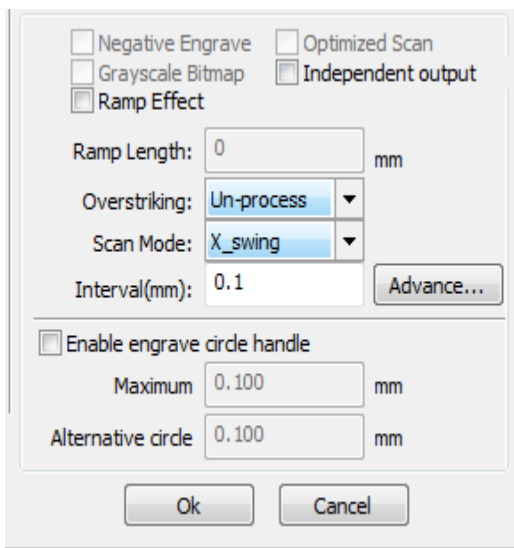


Figure 96 Vector Scan

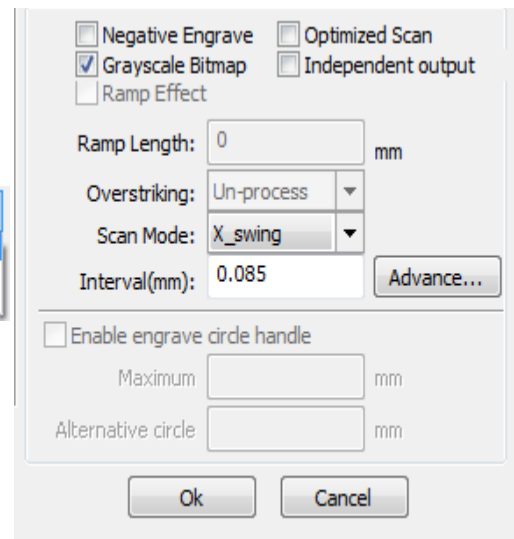


Figure 97 Bitmap Scan

Figure 96 illustrates the Layer Parameter pop-up as it appears when a vector object layer is selected and Processing Mode is set to Scan.

Figure 97 illustrates the Layer Parameter pop-up as it appears when a bitmap object layer is selected and Processing Mode is set to Scan.

**Negative Engrave:** flips Black & White. Used with dark materials to make the etching show.

**Ramp Effect:** gives the effect of a 3D cut as if a V-Bit had been used.

**Independent Output:** cuts one object or letter at a time.

**Vector Scan:** does not support certain functions. In **Figure 96** the unsupported ones are grayed out.

**Bitmap Scan:** supports all except for Ramp Effect and the Engrave Circle handle functions that are grayed out in **Figure 97**.

**Optimized scanning:** Choose optimized scanning to automatically adjust the scan to the scanning interval for best effect. Otherwise, the user settings of the scanning interval scan pattern are applied. It is generally advisable to choose "optimal scanning."

**Output direct: (Grayscale Bitmap)** As referred to the image, higher power will be associated with deep/dark colors, on the other hand, for shallow/light colors will have lower power outputs. This works fine for glass and clear acrylic, however if you want to put an image onto slate for example you might need to check "**Negative Engrave**".

**Scan mode:** There are four different scanning modes: X\_unilateralism, X\_swing, Y\_unilateralism and Y\_swing.

**X\_unilateralism:** The scanning pattern of a back and forth motion in a horizontal direction, in which the laser is firing from left to right OR right to left (uni-directional).

**X\_swing:** Refers to the optical horizontal direction in the back and forth scanning of graphics, in which the laser is firing from left to right AND right to left (bi-directional).

**Y\_unilateralism:** The scanning pattern of a back and forth motion in a vertical direction, in which the laser is firing from up and down OR down and up (uni-directional).

**Y\_swing:** Refers to the optical vertical direction in the back and forth scanning of graphics, in which the laser is firing from up and down AND down and up (bi-directional).

**Overstriking:** If not set to Un-process, there are a choice of two methods, Intaglio and Relief. Relief cutting is where the letters or object is cut around and appears to be raised, frequently used to make rubber stamps. Intaglio is the opposite of relief cutting. Select the desired method. Relief requires a bounding area be defined.

**Interval (mm):** Refers to the spacing of scan lines. The smaller the number the closer the scan lines.

Suggestions: For vector layers (i.e. color layers), the scanning interval should be set to 0.1 mm or less. For a BMP layer, the scanning interval should be set to 0.1 mm or above. Then change the maximum power and the minimum power to achieve the ideal effect.

#### 4.10.4 Laser Dot Parameters Setting

The screenshot shows a 'Parameter library' dialog box with the following settings:

- Layer: [Redacted]
- Is Output: Yes
- Speed(mm/s): 400
- Is Blowing: Yes
- Processing Mode: Dot
- Min Power(%) 1: 18, Max Power(%) 1: 18
- Min Power(%) 2: 0, Max Power(%) 2: 0
- Min Power(%) 3: 0, Max Power(%) 3: 0
- Min Power(%) 4: 0, Max Power(%) 4: 0
- Dot time: 0.100 s
- Dot interval: 5 mn
- Dot length: 0 mn
- Center dot: [unchecked]

Figure 98

This function is useful for making dot type perforations.

**Dot Time:** specifies how long the laser will be fired for a dot if the Dot Length is zero.

**Dot Interval:** specifies the distance from the start of one dot to the start of the next.

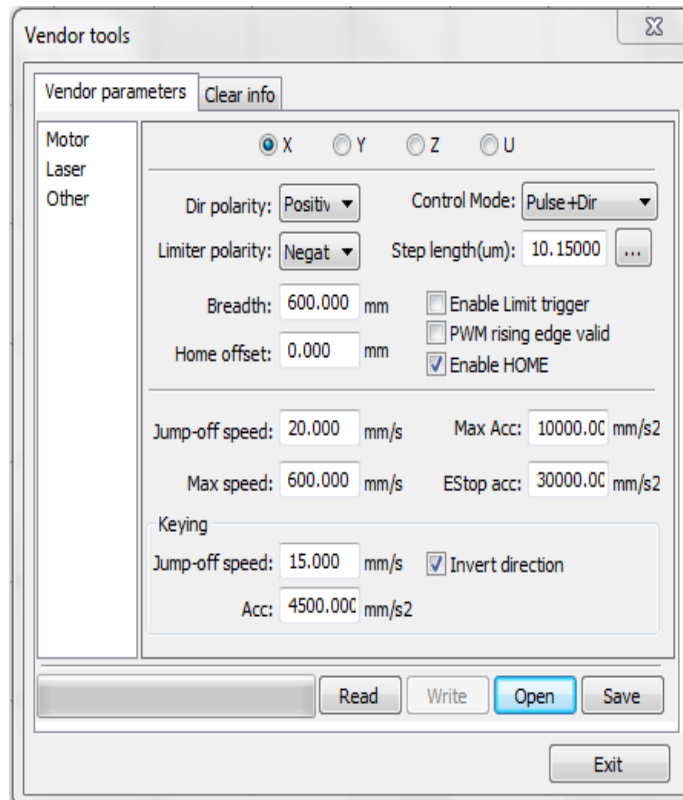
**Dot Length:** specifies the length of each dot. If this is zero, the laser will be fired for Dot Time without moving. If it is non-zero, the laser head will move at the speed specified.

**Center Dot:** if checked, a single dot will be made at the center of every item on the layer.



#### 4.11 Vendor settings

Click menu [File] -> [Vendor Settings] to invoke the Vendor Settings Password Dialog. The vendor and machine settings are located here. When the password dialog pops up, Enter RD8888 and click OK.



**Figure 99**

Click on menu [File] -> [Vendor Settings] to invoke the Vendor Settings Password Dialog. The vendor and machine settings are located here. When the password dialog pops up, Enter RD8888 and click OK.

**IMPORTANT:** Before changing any settings, make a backup. With the machine connected to the computer and turned on, select "**Read**" to read the settings from the laser control board to RDWorks. Next, select "**Save**" to save a copy to a safe location on your computer or an external source such as USB drive or optical disc. This backup is critical if you need to restore your settings.

#### **4.11.01 Motor parameters**

**Motor** - These settings “*Should*” have been set correctly by the machine manufacturer or your dealer. Each axis is setup separately. The X axis is the side to side axis. The Y axis is the front to the back axis. Z is the up and down axis and will be setup if you have an autofocus motorized platform. It may also be used with some manual up and down systems. U may be used for a dedicated rotary axis or for a feed mechanism. The “Breadth” (Width) setting is the axis length. For the X axis, it is the machine cutting distance from side to side. For the Y axis, it is the machine cutting distance from back to front. For the Z axis, it is the distance to the lowest part of the table. Click on the radio button for the desired motor axis.

**Dir Polarity:** determines the direction of movement and depends on the location of the machine origin. It should be set so that the laser head moves toward the machine origin at reset. More precise detail cannot be given - -ve/+ve could be in either direction depending how the motors are wired.

**Limiter Polarity:** must be set according to whether the Limit switch goes low (negative) or high (positive) when triggered.

**Breadth:** is the amount of movement available for this axis. The controller will not move the axis beyond this distance. Set to your machine size in each axis.

**Home Offset:** is the distance from the limit switch of the 0 point of this axis. It should be in the range 0-5mm. If Hard Limit Protection is set for this axis, Home offset should not be less than 2mm to prevent emergency stop of the axis if the hard limit is triggered wrongly. A non-zero Home Offset CANNOT be used to prevent the “No enough extend space” error. The space between the machine zero and the Home Offset position is 'dead space'.

**Control Mode:** may be “Pulse + Direction” or “Double PWM”, and must be set according to the motor drivers in use. Default is “Pulse + Direction”.

**Step Length:** is the distance moved on this axis for one step of the motor. This can be calculated automatically, by cutting a shape of known dimensions and measuring the actual size of the shape. Press the ellipsis button (...) and enter the drawn (graph length) dimension and the measured (measuring length) dimension and press OK. The Step length will be calculated. X & Y will be close to the same, and Z will usually be different.

**Enable Limit Trigger:** is checked to enable Hard Limit (Limit Switch) Protection on this axis.

**PWM Rising Edge Effective:** must be set according to whether the Rising or Falling edge of the motor driver pulse is effective.

**Enable Home:** should be set if this axis is actually configured in the machine. If it is not checked, the controller will not attempt to return this axis to the home position at reset. This is also set in user Parameters.

**Jump Off Speed:** is the initial speed of this axis. If it is set too fast, the motion may be irregular. Typical values such as 5 - 30 mm/s.

**Max Speed:** is the maximum speed for this axis. Typical values such as 200 - 900 mm/s.

**Max Acc:** is the maximum acceleration rate allowed for this axis. If it is set too high, the motion may be irregular. If too low, it will adversely affect the time taken to complete jobs. The Y axis has a typical setting in the range of 800 - 3000 mm/s<sup>2</sup> corresponding depending on inertia of the head. The X axis has a typical setting range of 8000 - 20000 mm/s<sup>2</sup>.

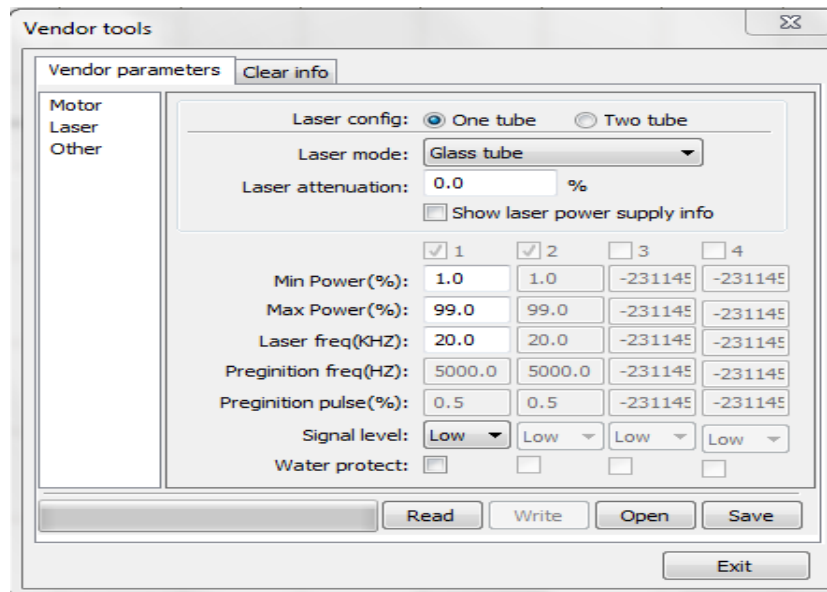
**Estop Acc:** is the acceleration rate allowed if the emergency stop is triggered. This value may be 2 - 3 times the maximum acceleration.

**Keying Jump Off Speed:** is the initial speed of this axis when a control panel button is pressed. It cannot be higher than Jump Off Speed above.

**Keying Acc:** is the acceleration of this axis when operated from the control panel. It cannot be higher than Max Acc above.

**Invert Direction:** reverses the movement of the axis when the control panel (LCD) key is pressed, e.g. to make the right arrow move the laser head to the left.

### 4.11.02 Laser parameters:



**Figure 100 Laser Parameters**

**Laser Config:** select the radio button according to how many lasers are installed.

**Laser Mode:** must be set according to the type of laser tube(s) installed.

**Laser attenuation:** causes the head to move more slowly as it is increased from zero. This is for a laser that is down on power.

**Show Laser power supply info:** **has no effect that has been see.**

**Min Power:** is the minimum power that will be demanded from the laser. If lower power is set in the Layer Parameters or on the Control Panel, the actual output will be increased to this level.

**Max Power:** is the maximum power that will be demanded from the laser. If higher power is set in the Layer Parameters or on the Control Panel, the actual output will be decreased to this level.

**Laser Freq:** is the PWM Control signal frequency for the tube, typically 20KHz for glass tubes and 5KHz for RF Tubes.

**Pre-ignition Frequency:** is required only for RF tubes with pre-ignition.

**Pre-ignition Pulse:** is required only for RF tubes with pre-ignition.

**Signal Level:** is required only for glass tubes and must be set to the input level required – either low or high.

**Water Protect:** should be checked if a water flow sensor (or other cooling system) signal is input to the controller. If the signal is not detected the machine will be stopped. If no sensor is fitted this should be un-checked.

#### 4.11.03 Other Vendor parameters

There are several parameters that allow setting the Machine type as well as adjusting the Transmission mode, Feed mode and Broken delay and selecting what the Z function does.

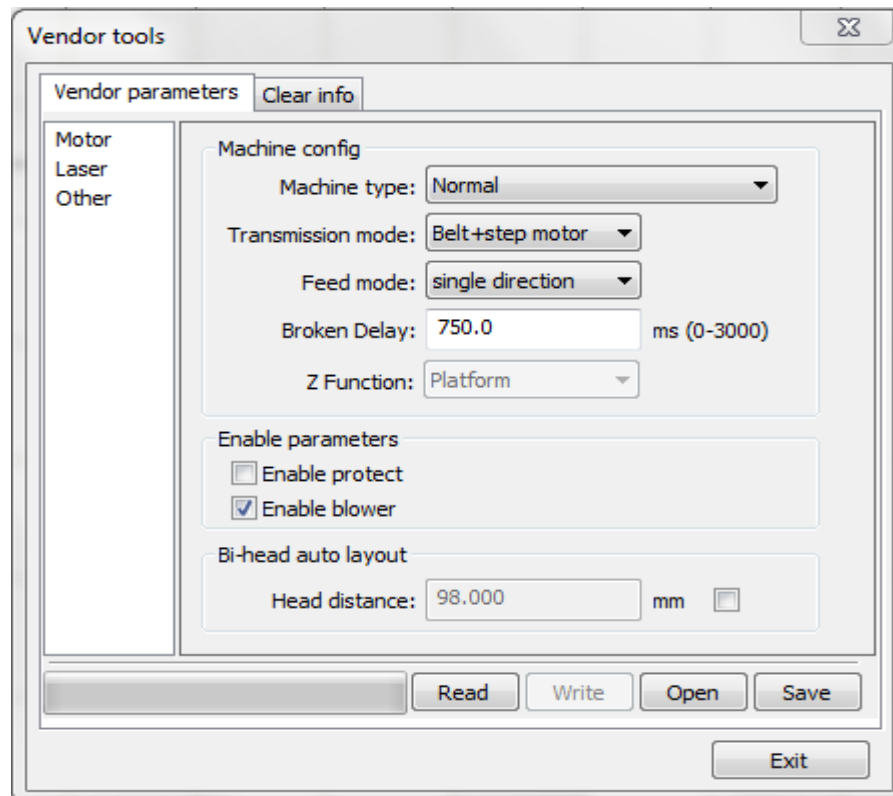


Figure 101 Other Parameters

#### Other Parameters (Figure 101):

**Machine Type:** should usually be Normal unless you know better.

**Transmission Mode:** should usually be Belt Stepping Type, other modes have slightly different control algorithms.

**Feeding Mode:** should be set according to the type of material feeding system fitted. This parameter is only valid if the Z Function is set to "Drive for Feeding Axes". If this is Bidirectional, settings in the Z axis motor parameters control how the feed system works.

**Broken Delay:** The controller can continue operation when power is restored after an interruption. Broken Delay allows adjustment of the position from which it will resume and should be set to minimize the gap or overlap in the cut or engraving.

**Z Function:** defines the purpose of the Z Axis. It may be used as a rise-fall platform or as a material feed.

**Enable Protect:** should be unchecked if no lid or cover interlocks are fitted to the machine. If interlocks are fitted, check this to prevent the machine being operated with the lid open.

**Enable Blower:** should be checked to allow the 'If Blowing' parameter of each layer to control the air assist function. This would require a relay if one is not installed.

**Head Distance:** is the distance between the two heads on a dual-headed machine.

**4.11.04 Clear info:** Clicking on this tab will allow parameters to be reset to “0”. When you initially receive the machine, it is **highly likely** that these are random numbers and have no bearing to actual use. It is a good idea to reset these to “0” when you first start using the machine. To do this, click on the “**Clear info**” tab and select the items to be cleared. Initially, leave all checked. Then, with the laser power up, click on “Execute” and enter “RD8888” again. This will clear all the numbers and reset to “0”. Doing so will then allow one to accurately determine use.

## ADDENDUM

### How to Correct X Y Scaling Factor

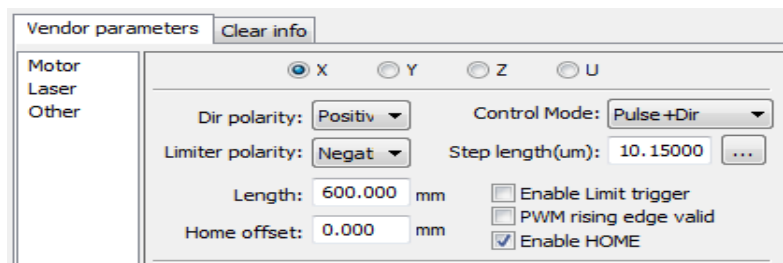
If your machine is not cutting the correct size it can be calibrated to be more accurate. Here are the steps to take to correct this problem.

The first step is to power up your laser and connect it to your computer. Place a piece of material that you will use for your test cuts on the cutting bed. **The bigger the better.** If your machine is cutting to big, draw a box that is 50mm smaller in both X and Y dimensions. Cut the file. Then, use a metric tape measure to measure the actual cut in both the X and Y directions. Be as accurate as possible.

Now, click on menu, [File] -> [Vendor settings]. Under vendor settings you need to enter the password "RD8888"

First thing you should do is load the settings from your machine, then save a copy of those settings. Click on "**Read**" and once the settings have loaded, click on "**Save**", enter a filename and save those settings. These will be your default settings, just in case things go wrong and you need to revert back to the factory settings. When everything is scaled correctly, you will do this again to "Write" to the laser and then "Save" as your backup settings.

**The scale factor** is labeled step length. Click on the button with the three dots.



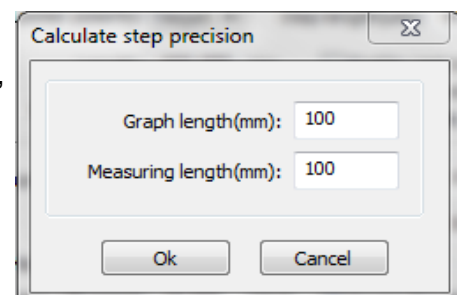
**Figure 102**

Enter the length of the box you drew in the graph length. And enter the actual length of your test cut under measuring length. Click on "Ok".

The Y axis is next, you will need to click on the Y radio button, followed by the step length button.

Repeat the steps for the depth - height of your test cut.

Now you can save your corrected settings, and write them to the machine.



**Figure 103**

Follow up with another test cut and do again if needed. Once you have the correct scale settings, WRITE, READ and SAVE these settings as your backup.

## **Cutting Multiple Passes**

In looking for a way to generate multiple passes, it occurred to me that using the feed parameters might work. I just verified that enabling feeding and entering a count greater than 1 will process the file multiple times. Note, I do not have a feeder on my machine, I am just using this software feature to get what I want. For example, when cutting foam board, I find I get an excellent cut if I run at 11% power and 3 or 4 passes. Previously I would wait for the job to finish and manually rerun it. This is much more convenient.

Setting the distance to 0 speeds up the recycle time.